

**CITY OF JOLIET
WILL COUNTY, ILLINOIS
SPECIFICATIONS, PLANS, CONTRACT PROPOSAL,
CONTRACT AND CONTRACT BOND**

**FOR THE
BETHEL/DOUGLAS/KUNGS/WALSH WATER MAIN IMPROVEMENT
PROJECT – 2016**

CONTRACT NO. 2143-0316

(PRE-QUALIFICATION REQUIRED THROUGH THE ILLINOIS DEPARTMENT OF TRANSPORTATION OR
CAPITAL DEVELOPMENT BOARD)

**APPROVED
DEPARTMENT OF PUBLIC UTILITIES**

James E. Eggen
DIRECTOR OF PUBLIC UTILITIES

DATE: January 27, 2016

**APPROVED
DEPARTMENT OF PUBLIC UTILITIES**

Bob J. Mui
PUBLIC UTILITIES ADMINISTRATOR

DATE: January 27, 2016

SUBMITTED BY

CONTRACTORS NAME

ADDRESS

CITY AND STATE

PHONE

DATE: _____, 2016

**This page
intentionally
left blank**

MANAGEMENT & BUDGET
PURCHASING DIVISION
815/724-3925
815/724-3929 FAX

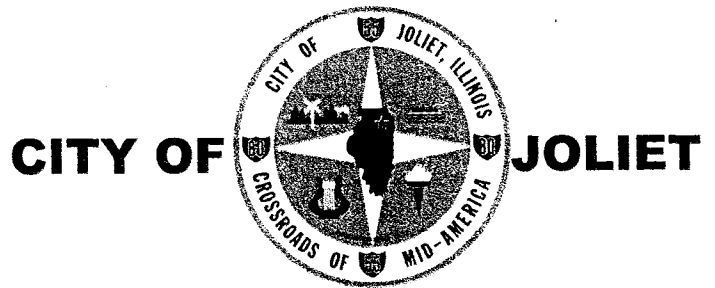

150 WEST JEFFERSON STREET
JOLIET, ILLINOIS 60432-4158

Prospective Bidder:

Enclosed are bid documents which may be of interest to your company.

Please note the date as to when these bids will be opened.

THIS BID DOCUMENT MUST BE RETURNED INTACT (THE SAME ORDER AS RECEIVED).
FAILURE TO DO SO MAY INVALIDATE YOUR PROPOSAL.

ALL BIDS SHALL BE SUBMITTED IN AN OPAQUE, SEALED ENVELOPE TO THE CITY CLERK, 150 WEST JEFFERSON STREET, JOLIET, ILLINOIS 60432, PRIOR TO THE TIME AND DATE SET FORTH FOR BID OPENING IN THE NOTICE TO BIDDERS. EACH BID SHALL BE ADDRESSED TO THE CITY CLERK AND SHALL BEAR ON THE FACE OF THE ENVELOPE THE NAME OF THE BIDDER, AND A STATEMENT THAT IT IS A SEALED BID, TO BE OPENED FOR THE CONTRACT CONSIDERED, AT THE DATE AND HOUR SET FORTH IN THE INVITATION TO BID.

THE BIDDER SHALL ALSO STATE ON THE ENVELOPE THAT HE/SHE IS IN RECEIPT OF ALL ADDENDUMS TO THE CONTRACT.

ANY QUESTIONS OR CLARIFICATIONS CONCERNING THESE SPECIFICATIONS SHOULD BE DIRECTED TO MARGARET E. MCEVILLY, CONTRACT ADMINISTRATOR, PHONE NO. (815) 724-3925 OR (815) 724-3929 FAX.

ANY ORAL OR WRITTEN COMMENTS RECEIVED FROM ANY OTHER PERSON OTHER THAN THE CONTRACT ADMINISTRATOR, WILL NOT BE CONSIDERED AND ALSO, MAY INVALIDATE YOUR PROPOSAL.

THANK YOU FOR BIDDING.

MAYOR

Robert O'DeKirk

CITY MANAGER

James D. Hock

COUNCILPERSONS

Bettye Gavin
John E. Gerl
Larry E. Hug
Jim McFarland
Terry Morris
Pat Mudron
Jan Hallums Quillman
Michael F. Turk

CONTRACT ADMINISTRATOR

Margaret E. McEvilly

CONTRACT DOCUMENTS

**PROJECT: BETHEL/DOUGLAS/KUNGS/WALSH WATER MAIN
IMPROVEMENT PROJECT – 2016**

**DEPARTMENT: PUBLIC WORKS AND PUBLIC UTILITIES
CITY OF JOLIET, ILLINOIS**

CONTRACT NO. 2143-0316

**JAMES D. HOCK
CITY MANAGER**

**MARGARET E. McEVILLY
CONTRACT ADMINISTRATOR**

LEGAL NOTICE
CITY OF JOLIET
ADVERTISEMENT TO BIDS

CONTRACT NO. 2143-0316

**BETHEL/DOUNGLAS/KUNGS/WALSH WATER MAIN IMPROVEMENT PROJECT –
2016**

The City of Joliet, Illinois, does hereby invite sealed bids for **6,050 lineal feet of ductile iron water main, various sizes, 4,550 square yards of hot mix asphalt removal & replacement 4", 90 water service connections, topsoil & seeding restoration & various water main related items.**

Bids will be received at the Office of the City Clerk, City of Joliet Municipal Building, 150 West Jefferson Street, Joliet, Illinois 60432-4156 until **10:00 A.M.** local time on **Wednesday – February 24, 2016** at which time they will be opened and publicly read aloud.

Those desiring to submit a proposal may pick up the Request for Proposal in the City of Joliet Purchasing Division, 150 W. Jefferson St., Joliet, IL 60432 between the hours of 8:00 A.M. and 4:30 P.M., Monday through Friday. Electronic copies can be downloaded free of charge at <http://www.cityofjoliet.info/departments/finance/purchasing/bids-proposals>. All bidders will be required to submit Bid Security in the form of a Certified Check, Cashier's Check or a Bid Bond in the amount of **Ten percent (10%) of the Base Bid**, payable to the City of Joliet.

The successful bidder will be required to post performance Security and to provide a Certificate of Insurance as set forth in the Invitation of Bid and the General Terms & Conditions.

Bidders are required to be pre-qualified through the Illinois Department of Transportation or the Capital Development Board. The City of Joliet reserves the right to reject any and all bids, parts of any and all bids, or to waive technical errors or omissions in bids.

The Contract shall be subject to the provisions of the *Prevailing Wage Act (820 ILCS 130/1 et seq.)* to the extent required by law.

ALL PROPOSALS ARE SUBJECT TO THE REQUIREMENTS OF THE CITY OF JOLIET PROCUREMENT CODE (Section 2-430 - 2-453 of the Code of Ordinances)

HARD COPY BID DOCUMENT FEE: \$50.00

Published in the Herald News

MONDAY – FEBRUARY 8, 2016

James D. Hock
City Manager

TUESDAY – FEBRUARY 9, 2016

Margaret E. McEvelly
Contract Administrator

**This page
intentionally
left blank**

This contract is eligible for the local bidder preference ordinance.

If you have read all of the documentation, filled out the form found online at

<http://www.cityofjoliet.info/departments/finance/purchasing/prequalification-process>, have been prequalified by the City of Joliet as a Local Bidder and wish to be qualified as a local bidder for this contract, please sign this sheet.

VENDOR NAME _____

VENDOR ADDRESS _____

CITY, STREET, ZIP _____

CONTACT PERSON _____

SIGNATURE _____

PHONE _____

EMAIL ADDRESS _____

Complete this form ONLY if you submitted the CITY OF JOLIET LOCAL BIDDER APPLICATION FORM from the above website AND have been approved as a local bidder.

Also, please note, there may be other prequalifications that apply to this contract, like Capital Development Board or City of Joliet Financial Prequalification. Please review what is due and note this does not take the place of any of those documents.

This page
intentionally
left blank

CITY OF JOLIET

150 WEST JEFFERSON STREET

JOLIET, ILLINOIS 60432-4158

CONTRACT DOCUMENTS FOR:

BETHEL/DOUGLAS/KUNGS/WALSH WATERMAIN IMPROVEMENT PROJECT -2016

User Department: PUBLIC UTILITIES

Date and Time of Bid Opening: WEDNESDAY, FEBRUARY 24, 2016 @ 10:00 A.M.

Bid Security: 10%

Performance Security: 100%

Prequalification Necessary: YES – IDOT OR IL. CAPITAL DEVELOPMENT BOARD PREQUALIFICATION REQUIRED

Insurance: YES – The City of Joliet and its officers and employees are to be named as additional insured on a primary and non-contributory basis. Additionally, please provide an endorsement from your insurance carrier confirming the City of Joliet is additional insured, including the provision of legal representation in the defense of claims asserted against the City of Joliet.

Robert O'Dekirk

Mayor

**James D. Hock
City Manager**

**Margaret E. McEvilly
Contract Administrator**

Council Members:

**Bettye Gavin
John E. Gerl
Larry E. Hug
Jim McFarland
Terry Morris
Pat Mudron
Jan Hallums-Quillman
Michael F. Turk**

NOTICE

The City of Joliet has adopted the Responsible Bidder Ordinance. In addition to any other requirement, unless otherwise expressly stated in a bid solicitation or an award of contract, all bidders must comply with the following requirements in order to submit a bid or be awarded a contract and include satisfactory evidence thereof in its bid.

(1) The bidder must be a duly organized legal entity in good standing with the Illinois Secretary of State and in compliance with all laws prerequisite to doing business in Illinois.

(2) The bidder must have a valid Federal Employer Tax Identification Number or Social Security Number.

(3) The bidder must be an equal opportunity employer and comply with Section 2000(e) of Chapter 21, Title 42 of the United States Code and Executive Order No. 11246.

(4) The bidder shall provide certificates of insurance indicating the following coverages if called for in the bid solicitation: general liability, workers compensation, completed operations, automobile, hazardous occupation and product liability.

(5) The bidder must comply with all provisions of the Illinois Prevailing Wage Act (820 ILCS 130), including wages, medical and hospitalization insurance and retirement for those trades covered in the Act.

(6) All contractors and sub-contractors performing services covered by the Illinois Prevailing Wage Act must submit to the City the certified payrolls required by the Act, as amended by Illinois Public Act 94-0515.

(7) For construction projects (construction of new facilities, renovation of existing facilities or road construction projects) over \$25,000.00, the bidder must provide apprenticeship and training programs that are either registered with the United States Department of Labor's Bureau of Apprenticeship and Training or are reasonably equivalent to such programs.

MARGARET E. MCEVILLY
Purchasing/Contract Administrator

INSTRUCTION TO BIDDERS

PROJECT:

BETHEL/DOUGLAS/KUNGS/WALSH WATER MAIN IMPROVEMENT PROJECT-2016

NOTE: BY SUBMITTING A BID, THE BIDDER WARRANTS THAT HE HAS FAMILIARIZED HIMSELF WITH ALL REQUIREMENTS OF THE CONTRACT DOCUMENTS AS WELL AS THE CITY OF JOLIET PURCHASING ORDINANCE.

DEFINITIONS:

The following definitions shall apply wherever they appear in the contract documents.

CITY:	CITY OF JOLIET
OWNER:	THE CITY OF JOLIET
BID:	THE OFFER OF THE BIDDER
BIDDER:	ANY INDIVIDUAL, CORPORATION OR PARTNERSHIP WHO SUBMITS A BID.

CONTRACT DOCUMENTS - Invitation to Bid Instructions, General Conditions, Special Provisions, Specifications, Drawings, Addendums, Proposal (in so far as it is not inconsistent with other contract documents) and Contract Form.

Other definitions shall be as defined in City of Joliet Ordinance 7345 or in other Contract Documents.

1. BIDS - GENERAL

Bids shall be made in accordance with the instructions. Failure to execute proposals as required may, in the discretion of the City, be cause for rejection of the bid.

2. FORMS

Bids shall be submitted on the forms provided by the City of Joliet. Each bid must be submitted bound with all other contract documents.

3. BLANKS; CORRECTIONS

All blank spaces on any contract document shall be filled in with typewritten figures or ink. Any erasures or corrections shall be dated and initialed by the bidder.

4. SUBMISSION

Bids shall be submitted in opaque sealed envelopes to the City Clerk, 150 West Jefferson Street, Joliet, Illinois 60432-4156, prior to the time and date set forth for bid opening in the Notice to Bidders. Each bid shall be addressed to the City Clerk and shall bear on the face of the envelope the name of the bidder, and a statement that it is a sealed bid to be opened for the contract at the date and hour as set forth in the invitation to bid.

5. EXECUTION

Proposals shall be signed by the bidder. If the bidder is a corporation, the proposal shall bear the name of the corporation, signed by an officer authorized to bind the corporation, and sealed with the corporate seal.

6. WITHDRAWAL

Bids may be withdrawn previous to the time of the bid opening by written request. However, no bid shall be withdrawn within the thirty (30) day period after the time set for bid opening. Bidders withdrawing their bids prior to the time and date set for bid opening may still submit another bid if done in accordance with these instructions.

7. WORDS AND FIGURES

Where amounts are given in both words and figures, the words will govern.

8. UNIT PRICE

When unit prices are called for, bids shall include all unit cost items and alternatives shown on the proposal. When an error is made in extending total prices, the unit price will govern.

9. TAXES

All bids shall include all applicable taxes. The State of Illinois Sales Tax and Federal Excise Taxes are not applicable to sales made in the City.

10. NET PRICE

Bid prices shall be net, including therein transportation and handling charges F.O.B. City of Joliet, and shall further include all charges of whatsoever sort for labor and materials contained in the work or materials designated in the specifications and proposals.

11. BID SECURITY

Each bidder shall provide bid security in the amount of at least **Ten percent (10%)** of its base bid. Bid security shall be in the form of a certified check, cashier's check or bid bond issued by a surety licensed to do business in the State of Illinois. Bid security shall be made payable to the order of the City of Joliet. Bid security shall be held to ensure good faith on the part of the bidder and to be applied as liquidated damages should the successful bidder fail to execute all required contract documents or attempt to withdraw the bid prior to execution of the contract.

Personal checks and Company checks are not acceptable bid security and may result in the rejection of the bid as non-conforming.

12. BID SECURITY RETURN

All bid security, other than submitted by the successful bidder, will be returned to the respective bidders upon the successful execution of the contract.

13. INTERPRETATIONS

Interpretations of the meaning of any item in the Contract Documents shall be valid only if issued in writing by the Owner or the Owner's representative designated in the Contract Documents.

14. FAMILIARITY WITH CONTRACT DOCUMENTS AND SITE

Bidders shall examine all contract documents including General Conditions and Specifications, inspect and acquaint himself fully with site conditions (surface and subsurface), working conditions and restraints, if applicable, prior to the submission of his bid.

15. ALTERNATE EQUIPMENT OR MATERIALS

- a. Bids shall be evaluated and considered on equipment and/or materials complying substantially with the contract specifications. If any bidder deviates from the contract specifications or provides a substitute for any required equipment and/or material listed in the contract specifications, that bidder shall list such deviations and/or substitutions, including technical data when applicable, in a letter attached to the bid or on a form that may be provided by the City with the bid documents.
- b. Brand names, which may be mentioned in the contract specifications, are used only as a reference to the type and quality of equipment and/or materials desired. However, any deviation from or substitution in a brand name stated in the contract specifications shall be listed as required under paragraph (a) of this section.
- c. The City reserves the right to determine whether any deviations and substitutions listed by the bidder are within the intent of the contract specifications and will reasonably meet the service requirements of the using department.
- d. A bidder's failure to list any deviations from or substitutions in the contract specifications as required under paragraph (a) of this section may result in the rejection of the bid.

16. DESCRIPTIVE LITERATURE: EQUIPMENT OR MATERIALS

Each bidder bidding on contracts to furnish equipment or materials shall furnish with his proposal two (2) copies of descriptive literature on the supplies or equipment being bid and manufacturer's specifications shall be in sufficient detail to permit proper evaluation of the bid.

17. RESPONSIBILITY OF BIDDERS

No contract will be awarded to any person, firm, or corporation that is in arrears to the City of Joliet, Illinois upon any debt or contract, or who has failed to execute in whole or in part, in a satisfactory manner, any contract with the City of Joliet, or who is a defaulter as to surety or otherwise upon any obligation to the City of Joliet, Illinois.

18. CITY'S RIGHT TO ACCEPT OR REJECT

The City of Joliet reserves the right to accept any bid which may be deemed to be in the best interest of the City of Joliet. The City of Joliet further reserves the right to reject any or all bids.

19. AWARDING OF CONTRACT

The Contract shall be awarded to the lowest responsible bidder based on criteria as set forth in the City of Joliet Purchasing Ordinance.

20. ALTERNATE AND MULTIPLE BIDS

Unless otherwise indicated in these bid documents, the Contractor may not submit alternate or multiple bids as part of this bid package. The submission of more than one bid within a single bid package may be cause for rejection of any or all of the bids of that contractor.

21. AFFIDAVITS

The Affidavits included in these Contract Documents must be executed and submitted with the bid.

GENERAL CONDITIONS

**Please see the City of Joliet Special Provision and General Conditions Booklet
Adopted January 1, 2013.**

Section 2-448(c). Insurance; all construction and demolition contracts.

- 1) The successful bidder in all construction and demolition contracts shall submit, with other required contract documents, a certificate of insurance, issued by an insurance company licensed to do business in Illinois, indicating the bidder as the insured and naming the City of Joliet (and its officers and employees) as additional insured with right of notice of cancellation for the duration of the contract in at least the following amounts:
 - a) General Liability Insurance – One Million Dollars (\$1,000,000) general liability insurance covering injuries, deaths and property damage.
 - b) Workers Compensation Insurance – amount required by Illinois law.
- 2) The successful bidder shall require the same amounts and coverages as in sub-section (1) from all subcontractors.
- 3) The amounts stated in sub-section (1)(a) shall be doubled for contracts exceeding Five Hundred Thousand Dollars (\$500,000).
- 4) The minimum amount of insurance may be modified and other insurance-related terms and conditions may be required in specific contracts as the Mayor and City Council may deem appropriate.

GENERAL CONDITIONS

CONSTRUCTION

1.0 GENERALLY

1.1 DEFINITIONS:

The following terms as used in these contract documents are defined as follows:

- (a) "City" – City of Joliet
- (b) "City Representative" – That person authorized or entity authorized by the City to act, give or receive information and direct the project in the City's behalf within the scope of the contract terms; in this contract:

JAMES E. EGGEN, P.E., DIRECTOR OF PUBLIC UTILITIES

- (c) "Contract Documents" – Includes Notice to Bidders, Instruction to Bidders, General Conditions, Proposal (only to be extent they do not limit or modify other contract documents), Special Conditions, Specifications, Addenda, Drawings and Contract.
- (d) "Contractor" – The person, firm or corporation to whom the contract is awarded by the Owner and who is subject to the terms thereof.
- (e) "Subcontractor" – A person, firm or corporation, other than a contractor supplying labor and materials or labor for work at the site of the project.
- (f) "Project" – The entire public improvements proposed by the Owner to be constructed in part or in whole pursuant to the contract.
- (g) "Owner" – City of Joliet, Illinois
- (h) "Surety" – Any person, firm or corporation that has executed as Surety, the contractor's performance bond securing the performance of the contract.
- (i) "Work" – The construction or installation required or reasonably inferred by the contract documents, including all labor, materials, and equipment.

In interpreting the contract documents, words describing materials or words which have well-known technical or trading meaning, unless specifically defined in the contract documents, shall be constructed in accordance with such well-known meaning recognized by architects, engineers or the trade.

1.2 INTENT OF THE CONTRACT DOCUMENTS:

The contract documents are complimentary, and what is called for by any one shall be as binding as if called for by all. The intention of the contract documents is to include in the contract price the cost of all labor and materials, equipment, transportation and all other expenses as may

be necessary for the proper execution of the work. If certain contract documents appear to be in conflict, the Contractor shall promptly bring these provisions to the attention of the City and the City shall determine the applicable provision.

1.3 PATENTS:

- (a) The contractor shall hold and save the Owner and its officers, agents, servants and employees harmless from liability of any nature or kind, including cost and expenses, for, or on account of, any patented or unpatented invention, process, article or appliance manufactured or used in the performance of the contract, including its use by the Owner, unless otherwise specifically stipulated in the Contract Documents.
- (b) License or Royalty Fees: License and/or Royalty Fees for the use of a process which is authorized by the Owner in writing must be reasonable, and paid to the holder of the patent, or his authorized license, directly by the Owner and not by or through the Contractor. Such fee shall be included in the contract price.

1.4 PERMITS AND REGULATIONS:

- (a) Permits and licenses necessary for the prosecution of the work shall be secured and paid for by the Contractor. Permits, license and easements for permanent structures or permanent changes in existing facilities shall be secured and paid by the Owner, unless otherwise specified.
- (b) The Contractor shall give all notices and comply with all laws, ordinances, rules and regulations bearing on the conduct of the work as drawn and specified.

1.5 SUBCONTRACTS – NOTIFICATION:

Prior to the beginning of work, the Contractor shall notify the City in writing of the names of the sub-contractors proposed for the principal parts of the work, and shall not employ any sub-contractor that the City objects to as incompetent or unfit.

1.6 ASSIGNMENT:

The Contractor shall not-assign this Contract or any part hereof without prior written consent of the City. No assignment of this Contract shall be effective unless it shall contain a provision that the funds to be paid to the assignee under the assignment are subject to a prior lien for services rendered or materials supplied for the performance of the work called for in said Contract in favor of all persons, firms or corporations rendering such services or supplying such materials.

1.7 NOTICE:

Where in any of the Contract Documents there is any provision with respect to the giving of any notice, such notices shall be deemed to have been given, as to the City, when written notice shall have been delivered personally to the City Clerk, or shall have been placed in the United States mails, postage fully prepaid, addressed to the City Manager of the City of Joliet, 150 West Jefferson Street, Joliet, Illinois; as to the Contractor when written notice shall have been delivered to any officer of the Contractor or when a written notice shall have been placed in the United States mails, postage prepaid, addressed to the Contractor, at the place stated in the papers prepared by him to accompany his proposal as the address of his permanent place of business; as to the Surety on the Performance Bond, when a written notice is placed in the

United States mails addressed to the Surety at the home office of such Surety or to its agent who executed such Performance Bond in behalf of such Surety.

2.0 TIME

2.1 PROGRESS SCHEDULE:

Within two (2) days after the notice to proceed has been issued, the Contractor shall supply to the City a written progress schedule specifying when the various phases of the work are to be completed. Such schedule shall be posted at all times at the site of the work and strictly adhered to.

2.2 BEGINNING WORK:

The Contractor shall begin the work within five (5) calendar days after the contract has been executed by the City and notice has been given to him.

2.3 COMPLETION OF WORK:

The Contractor shall fully complete the work to the satisfaction of the City within the time period specified in the proposal. Time is the essence of this agreement. All work shall be prosecuted in an orderly and diligent manner. The Contractor shall cooperate with and conform to the requests of the City to expedite particular portions of the work where such alteration of the Contractor's operation is deemed advisable by the City.

In the event no notice has been given but the work has nevertheless commenced, then such time shall begin to run from the actual commencement of work.

2.4 DELAYS:

If the Contractor is delayed in the completion of the work by any act of neglect of the City or by any other Contractor employed by the City, or by strikes, fire, lockouts, unavoidable casualties or any cause beyond the Contractor's control, then the time of completion will be extended for a reasonable time, such reasonable time as the City shall decide. The Contractor shall, within five (5) days from the beginning of any such delay notify the City in writing of the cause of delay and therein specify the number of days of extension requested. If such request is not made as herein provided, it shall be deemed waived. Weather conditions shall not be a justifiable cause for delay.

2.5 PROGRESS REPORTS:

No less than bi-weekly, the Contractor shall meet with the City's representative on the City's premises to detail performance on the work and to report on compliance or noncompliance with the progress schedule. If in the opinion of the City, the Contractor has fallen behind the progress schedule, the Contractor shall take such steps as may be necessary to improve the progress. The City may require the Contractor to increase the number of shifts or overtime operations without addition to the Contract price.

2.6 LIQUIDATED DAMAGES FOR DELAY:

As actual damages for any delay in completion of the work which the Contractor is required to perform under this contract are impossible of determination, and the City and the public will suffer damage from delay in the completion of this contract, the Contractor and his sureties shall be liable for and shall pay to the City of Joliet, Illinois the sum of Twenty-five Dollars (\$25.00) as fixed, agreed and liquidated damages for each calendar day of unjustified deviation from the date specified in the proposal for completion.

3.0 PLANS, SPECIFICATIONS AND DRAWINGS

3.1 CONFORMITY:

The work shall be executed in strict conformity with the plans, drawings and specifications, and the Contractor shall do no work without drawings and specifications.

3.2 AVAILABILITY AT SITE:

The Contractor shall keep a copy of all plans, drawings and specifications at the work site in good order.

3.3 CONSISTANCY:

The several parts of the plans, drawings and specifications shall be taken and construed together to explain each other and make the whole consistent.

3.4 FIGURED DIMENSIONS TO GOVERN:

Dimensions and elevations shown on the plans shall be accurately followed even though they differ from scaled measurements. No work shown on the plans, the dimensions of which are not indicated, shall be executed until necessary dimensions have been obtained from the City's representative.

3.5 FAMILIARITY WITH SITE, PLANS, SPECIFICATIONS AND DRAWINGS:

The Contractor represents that he has thoroughly acquainted himself as to the conditions of the site, both surface and subsurface, and with the meaning and accuracy of the plans, specifications and drawings. The owner shall not be responsible for any claims made by the Contractor due to claimed unfamiliarity or inaccuracies.

3.6 ERRORS/AND OMISSIONS:

If the Contractor discovers any error of omission in the plans, drawings or specifications or in the work undertaken and performed by him, he shall immediately notify the City and the City shall promptly verify or correct the plans, drawings and specifications. The Contractor's notifications shall be in writing and copy of his transmittal shall be forwarded to the Owner.

3.7 STANDARD SPECIFICATIONS:

Reference to standard specifications of any technical society, organization or association, or to codes of local, state or federal, authorities, shall mean the latest standard; code specification or tentative specification adopted and published at the date of taking bids, unless specifically stated otherwise.

3.8 PRESERVATION OF MONUMENTS AND STAKES:

The Contractor shall carefully preserve all monuments, benchmarks, reference points and stakes. In case of his destruction thereof, the Contractor will be charged with the expense of replacement, and shall be responsible for any mistake or loss of time that may be caused. Permanent monuments or benchmarks which must be removed or disturbed shall be protected until they can be properly referenced for relocations. The Contractor shall furnish materials and assistance for proper replacement of such monuments or benchmarks.

4.0 ACTUAL PERFORMANCE

4.1 SUPERINTENDENCE:

The Contractor shall give his personal superintendence to the work and have at the site of the work at all times a competent foreman, superintendent or other representative having authority to act for the Contractor.

4.2 EMPLOYEES:

The Contractor shall not hire or keep in employment any incompetent employees.

4.3 CONTRACTOR COOPERATION:

In the event that more than one Contractor is selected to implement the work, the Contractor agrees that he will cooperate fully with other Contractors. Each hereby agrees to make available to other Contractors all necessary documentation and information to enable the individual installations to be made efficiently and effectively.

4.4 MATERIALS AND WORKMANSHIP – QUALITY:

(a) **Materials:** Unless otherwise specifically called for in the specifications, all equipment, materials and articles incorporated in the work covered by this contract shall be new and of the best grade. When called for by the City, the Contractor shall at no cost furnish to the City for approval full information concerning the materials, equipment or articles to be incorporated in the work, including reasonable samples or test results when customary.

(b) **Workmanship:** All work performed shall be performed and accomplished in a first class and workmanlike manner to the satisfaction of the City and in accordance with the best practice and standards recognized in the field.

4.5 MATERIALS AND WORKMANSHIP – GUARANTEE:

The Contractor guarantees the equipment, materials, articles and workmanship used in the work or performed to be free from defects, suitable for the purpose intended and merchantable. He shall correct defective works and replace defective materials at his own cost which becomes apparent within one (1) year from the date such defective work or materials should have been reasonably discovered.

4.6 COMPLIANCE WITH LAW, NOTICES, PERMITS:

The Contractor shall give all notices required by, and comply with, all applicable laws and ordinances of the City or State of Illinois. Should the Contractor fail to observe the aforementioned laws or ordinances and do work at variance with any applicable law or ordinances, the Contractor shall correct the methods of doing such work without cost to the City, even if such deficiency is discovered after the date of final inspection or payment. Upon execution of the contract by the City, the City shall simultaneously issue permits under the jurisdiction of the City necessary for the work to be performed.

4.7 WORKING HOURS:

No work shall be done on Sundays, unless special order or permit shall be given by the City.

4.8 SANITARY FACILITIES:

The Contractor shall furnish, install, and maintain ample sanitary facilities for the workmen, as the needs arise.

4.9 USE OF SITE:

- (1) The Contractor shall confine his equipment, storage of materials, and operations to the limits prescribed by ordinances or permits, or as may be directed by the City, and shall not unreasonably encumber the site.
- (2) The Contractor shall comply with all reasonable instructions of the City, and the ordinances and codes of the City regarding signs, advertising, traffic, fires, explosives, danger signals, barricades, and fire prevention.

4.10 CUTTING AND PATCHING:

- (a) The Contractor shall do all cutting, fitting, or patching of his work that may be required to make his several parts fit together or to receive the work of other Contractors shown upon, or reasonably implied by, the Plans and Specifications for the completed project and he shall make good after them as may be directed by the City.
- (b) Any cost caused by defective or ill-timed work shall be borne by the party responsible therefore.
- (c) The Contractor shall not cut, dig, burn, weld to or otherwise alter or modify the work of any other Contractor without the consent of the City.
- (d) All cutting, fitting or patching shall be accomplished by only skilled tradesmen in their respective craft area.

4.11 EXISTING MATERIALS:

All existing materials and equipment removed under this contract shall remain the property of the City and shall be stored, removed and protected by the Contractor as directed by the City.

4.12 CLEANING UP:

The Contractor shall at all times keep the site free from accumulations of waste materials or rubbish caused by his employees or the work; and at the completion of the work he shall remove all his rubbish from the site and all his tools, equipment, scaffolding and surplus materials, and shall leave his work clean and ready for use. In case of dispute the Owner may remove the rubbish and surplus materials and charge the cost to the Contractor.

4.13 STARTING IN OPERATIONS:

Where required, the Contractor shall furnish a skilled operator to adjust and start all of the equipment installed and to put it in successful operation. After the equipment installed has been satisfactorily adjusted, the operator shall instruct the Owner's operators as to the proper method of starting, adjusting and caring for the equipment furnished and installed under these specifications.

5.0 SAFETY AND PROTECTION

5.1 PROTECTION OF WORK:

The Contractor shall continuously maintain adequate protection of all the work from damage and shall protect the City's and adjacent property from injury arising in connection with his contract.

5.2 CARE OF EXISTING PROPERTY:

All sewers, water, gas or other pipes, wires, conduits, trees, shrubbery, fences, and structures and other property shall be supported and protected from injury by the Contractor during the work performed under this contract. The Contractor shall be liable for all damages to such structures and property and shall save and keep the said Owner harmless from any liability or expense for injuries, damages or repairs to same.

5.3 ACCIDENT PREVENTION:

The Contractor shall exercise all reasonable precaution at all times for the protection of all persons and property and shall be responsible for all damages to persons or property, either on or off the site, which occur as a result of his fault or negligence in connection with the prosecution of the work. Final payment or inspection shall not be deemed a waiver of contractor's responsibility. The safety provisions of applicable law and building and construction codes shall be observed and the Contractor shall take or cause to be taken such additional safety and health measures as the City may determine to be reasonably necessary. Machinery, equipment and all hazards shall be guarded in accordance with the safety provisions of the "Manual of Accident Prevention in Construction" published by the Associated General Contractors of America, Inc., to the extent that such provisions are not in conflict with applicable local laws or such other generally recognized accident prevention manual as is applicable in the trade.

5.4 OSHA:

The Contractor shall observe and enforce upon subcontractors all applicable sections of the Occupational Safety and Health Act of 1970 as amended, and shall be subject to inspection by authorized officials for compliance.

5.5 OBSTRUCTION AND RESUMING TRAVEL:

Travel upon the highway, streets or upon any intersecting street or alley shall not be hindered or inconvenienced needlessly nor shall any portion of a roadway or street be opened up nor shall the same be wholly obstructed without the direction of the City, in which latter case the Contractor shall cause plain and properly worded signs announcing the fact to be placed with proper barricades at the nearest cross streets where travel can pass around the same in the shortest and easiest way. Travel may be resumed at the direction of the City upon any part of the street, or portion thereof, where the work has been completed, whenever public necessity or inconvenience may require, and the condition of improvement warrants it.

5.6 SPECIAL REQUIREMENTS:

- (a) **Fire Protection:** Temporary heating devices which are of the open flame type, with the exposed fuel below the flames and using such fuels as coke, oil or wood, are strictly forbidden. Temporary heating devices shall not be left unattended while being operated at night or non-work days or shifts.

All tarpaulins used for enclosures around structures or work areas shall be flame proofed.

- (b) **Grounding of Electrical Equipment:** All electrical construction equipment, including portable hand tools and all other apparatus, shall be grounded by a separate ground conductor (other than the service cords) or by multiple cord containing separate grounding conductor, all in accordance with requirements of the latest edition of the National Electrical Code.

6.0 SUB-CONTRACTORS

6.1 NO CONTRACTUAL RELATIONSHIP:

Nothing contained in the contract documents shall create any contractual relationship between any sub-contractor and the City.

6.2 APPLICABILITY OF CONTRACT DOCUMENTS:

The Contractor agrees to bind every sub-contractor (and every sub-contractor of a sub-contractor) and every sub-contractor agrees to be bound by the terms of the contract documents as far as applicable to his work, unless specifically noted to the contrary in a sub-contract approved in writing as adequate by the City.

6.3 RESPONSIBILITY OF CONTRACTOR:

The Contractor agrees to be fully responsible to the City for the acts or omissions of his sub-contractors and of anyone employed directly or indirectly by him or them and this contract obligation shall be in addition to the liability imposed by law upon the contractor.

7.0 INSPECTION; CORRECTION

7.1 ACCESS; NOTICE:

The City shall at all times have access to the work wherever it is in preparation or progress and the Contractor shall provide proper facilities for such access and for inspection. The Contractor shall not cover or proceed with the work until such work has been inspected. The Contractor shall give the City adequate notice of readiness for inspection of any work ordinarily requiring inspection.

7.2 REJECTION:

The City shall have the right to reject materials and workmanship which are defective or required their correction. Rejected workmanship shall be satisfactorily corrected, and rejected materials shall be removed from the premises both without charge to the City. If the Contractor does not correct such defective work and remove rejected materials within a reasonable time, fixed by written notice, the City may remove them and charge the expense to the Contractor.

7.3 INSPECTION AFTER COMPLETION:

Should it be considered necessary or advisable by the Owner at any time before acceptance of the entire work to make an examination of work already completed, by removing or tearing out same, the Contractor shall, on request, promptly furnish all necessary facilities, labor and materials for that purpose and the costs thereof shall be charged to the Contractor if the work was covered prior to inspection by the City.

7.4 NO WAIVER BY INSPECTION:

Neither the inspection of or payment for any provision in the contract documents shall relieve the contractor of the responsibility for negligence or faulty materials or workmanship within the extent and period provided by law and upon written notice and he shall remove any defects due therefrom.

7.5 DECISION OF CITY:

The signing of the contract for the work shall be considered the Contractor's agreement to accept the City's decision as final in all matters of workmanship and performance hereunder.

8.0 INSURANCE AND BONDS

8.1 CONTRACTOR'S INSURANCE:

The Contractor shall not commence work under this contract until he has obtained all insurance required under this paragraph and such insurance has been approved by the City, nor shall the Contractor allow any sub-contractor to commence work on his sub-contract until such insurance required of the sub-contractor has been so obtained and approved, and a certificate from the insurance companies shall be filed with the City.

- (a) Statutory Liability Insurance: Workman's Compensation and Occupational Disease, with statutory limits as prescribed by the State of Illinois and Employer's Liability Insurance with a limit of not less than \$250,000.00 for all damages or bodily injury from one or more claims arising from each accident or occupational disease.
- (b) Comprehensive Liability Insurance: This coverage shall be in the form of Comprehensive Liability Insurance which shall include protection against liability assumed in this contract and shall include protection against liability included in (1) and (2) following:
 - (1) Operation and Premises: Liability on account of:
 - (a) Bodily injury to or death of persons or on account of damage to or destruction of property, resulting from execution of work provided for in this contract; or due or arising in any manner from any omission or any act or negligence of the Contractor of any Sub-contractor and their respective employees or agents, including damage to adjacent property.
 - (b) Bodily injury to or death of Contractor or any Sub-contractor or any of their respective employees or agents, due to the condition or state or repair of the premises or other property of the City, upon, about, or in connection with which any work incidental to the executive of this contract is performed.
 - (c) Destruction or damage to personal or real property including but not limited to destruction or damage to the property of the City, destruction or damage to the property, homes or contents of the homes where the work is performed, and destruction or damage to the property of non-parties to this contract.
 - (2) Contractor's Protective Liability: Liability for acts or omissions of any sub-contractors, the Contractor may employ.
 - (3) Limited of Coverage: Policies for Comprehensive General Liability Insurance under subparagraphs (1) and (2) above shall be written in the following limits of liability:
 - (a) Bodily injury, including death resulting therefrom \$1,000,000.00 for any one person injured or killed, and \$1,000,000.00 for any one accident or occurrence where more than one person is injured or killed.
 - (b) Property damage of not less than \$1,000,000.00 as a result of any one accident or occurrence subject to an aggregate limit of not less than \$1,000,000.00.
 - (c) Proof of Insurance: Before commencing work, the Contractor shall submit his Statutory Liability Insurance and Comprehensive Public Liability Insurance Policies or Certificates of Insurance to the City for review and approval. He shall similarly submit his sub-contractor's policies of similar insurance before each commences work. Such insurance will be carried with financially responsible insurance companies, licensed in the State of Illinois and shall be kept in force until the Contractor's work is accepted by the City. Contracts of insurance shall be for the duration of the contract.
 - (d) City as Additional Insured: All policies of insurance required shall contain an endorsement showing the City as an additional insured under said policies.

8.2 PERFORMANCE BOND; LABOR AND MATERIAL PAYMENT BOND:

The Contractor shall not commence work under this contract until he has obtained and submitted both a Performance Bond and a Labor and Material Payment Bond to the City and such bonds have been approved by the City. Such bonds shall cover such performance, labor and materials used in the work whether by the Contractor or by any sub-contractor. Said bonds shall remain in full force and effect for the duration of the contract and during the term of any guaranty or warranty period required by the Contract Documents. The Performance Bond shall be conditioned on the full and faithful performance of the contract according to its terms and shall be in an amount of ONE HUNDRED PERCENT (100%) of the contract price.

The City reserves the right to require the successful bidder to supply a Performance Bond and a Labor and Materials Payment Bond issued by a surety authorized to do business in Illinois and having a current A.M. Best financial strength rating of not less than "A-". The bonds shall be filed within ten (10) calendar days of acceptance of the bidder's proposal by the City. The bonds, unless otherwise specified by the Purchasing Manager, shall be 100% of the total contract price. The form of all bonds shall be subject to the approval of the Corporation Counsel of the City.

9.0 ADDITIONAL PERFORMANCE SECURITY

9.1 RISK OF LOSS:

The City assumes no responsibility for the existence or condition of surface or subsurface structures, property or conditions in the project area nor for their continuance in the condition existing at the time of issuance of the Invitation for Bids or thereafter. No adjustment or contract price or allowance for any change in conditions or unknown conditions shall be made.

9.2 HOLD HARMLESS:

Contractor shall indemnify and save harmless the City and owners of the properties where the work is performed (hereinafter "Owners:") against any and all damages to property or injuries to or death of any person or persons, including property and employees or agents of the City, and shall defend, indemnify and save harmless the City and Owners from any and all claims, demands, suits, actions or proceedings of any kind or nature, including Workmen's Compensation claims, of or by anyone whomsoever, in any way resulting from or arising out of the operations in connection of the performance of this contract, including operations of sub-contractors and acts of omissions of employees or agents of Contractor or his sub-contractors. The City shall have the right to estimate the amount of such claims, demands, suits, actions, or proceedings for damage or injuries and pay the same, and any amounts so paid shall be deducted from the money due the Contractor under this contract; or the whole or so much of the money due or to become due the Contractor under this contract, as may be considered necessary by the City, shall be retained by the City until such claims, demands, suits, actions or proceedings shall have been settled or otherwise disposed of, and satisfactory evidence to that effect furnished to the City. Insurance coverage specified in these general specifications constitutes the minimum requirements and said requirements shall not lessen or limit liability of Contractor under the terms of the contract. Contractor shall procure and maintain at his own cost and expense, any additional kinds and amounts of insurance that, in his own judgement, may be necessary for his proper protection in the prosecution of the work.

9.3 TERMINATION:

- (a) In the event the Contractor voluntarily petitions for bankruptcy, or is adjudged bankrupt or makes a general assignment for the benefit of his creditors or if a receiver is appointed on account of his insolvency, or in the event that any of the provisions of this contract are violated by the Contractor or by any of his sub-contractors or the City reasonably believes such violation is likely, the City may serve written notice upon the Contractor and the Surety of the intention to terminate such contract. Such notice shall contain the reasons for such intent to terminate the contract. Unless within five (5) days after the serving of such notice upon the Contractor such violation shall cease and arrangements satisfactory to the City for correction be made, the contract shall upon expiration of said five (5) days cease and terminate with no further notice. In the event of any such termination, the City shall immediately serve notice thereof upon the Surety, and the Surety shall have the right to take over and perform the contract, provided, however, that if the Surety does not commence performance thereof within seven (7) days from the date of the mailing to such Surety notice of termination, the City may take over the work and prosecute the same completion at the expense of the Contractor, and the Contractor and his Surety shall be liable to the City for any excess cost occasioned to the City thereby, and in such event the City may take possession of and utilize in completing the work, such materials and equipment including those of the Contractor as may be on the site of the work and necessary therefore.
- (b) In the event of termination, the Contractor shall pay to the City, all costs over and above the contract price expended by the City in the completion of the work and this obligation shall survive the termination of the contract. Such payment shall not preclude or waive the City's entitlement to additional damages or be construed as an election of remedies.

9.4 CITY'S RIGHT TO WITHHOLD CERTAIN AMOUNTS /MAKE APPLICATION THEREOF

In addition to the payments to be retained by the City under the other provisions of these General Conditions, the City may withhold a sufficient amount of any payment otherwise due to the Contractor to cover the following:

- (1) For claims arising in and from the performance of the work on the project under this contract.
- (2) For defective work not remedied.
- (3) For failure of the Contractor of sub-contractors to make proper payments to his sub-contractors and suppliers. The City shall have the right to act as agent for the Contractor in disbursing such funds as have been withheld pursuant to this paragraph to the party or parties who are entitled to payment therefrom. The City will render to the Contractor a proper accounting of all such funds disbursed in behalf of the Contractor; and such payments shall be considered as payment made under the contract. The City shall not be liable to the Contractor for any such payment made in good faith.

10.0 CHANGE ORDERS

10.1 CHANGE ORDER/DEFINED:

A Change Order is defined as a written order by the City to the Contractor, issued after a contract has been executed, authorizing a change in the work to be performed thereunder, the

amount of money to be paid under the contract, or the time within which the contract must be performed.

10.2 AUTHORITY TO BIND CITY:

The City will be bound by and liable for only those change orders executed in the following manner:

- (a) The City Manager or his designee is hereby empowered to execute the following Change Orders:
 - (1) Change Orders which do not alter the scope or cost of the project.
 - (2) Change Orders which result in a reduction in cost, but do not alter the scope or quality of the project.
- (b) The City Manager or his designee is empowered to execute the following Change Orders without prior approval by the City Council, provided, however, he shall report such Change Orders to the City Council within two (2) weeks of such execution:
 - (1) Change Orders which result from emergency situations, defined as:
 - (a) Any clear and present danger or hazard to health, safety or welfare, or;
 - (b) A condition which would require the cessation of work on the project, if not immediately executed.
 - (2) Change Orders which result in an additional project cost, if the accrued costs of all Change Orders to date does not exceed the lesser of \$5,000.00 or ten percent (10%) of the original cost.
 - (a) All Change Orders not included in (a) or (b) above shall be effective only after prior approval by a majority of the Council holding offices. If such approval is given, the City Manager is hereby authorized to execute the Change Orders.

10.3 METHOD:

The City, without invalidating the contract, may order extra work or make changes by altering, adding to, or deducting from, the work. The contract sum shall be adjusted by the unit prices contained in the contract or if unit prices are not contained therein, by written agreement of the Contractor and the City. All such work shall be executed under the conditions of the original Contract except that any claim for extension of time caused thereby shall be adjusted as the time of ordering such change. No changes in the work shall be effective except with the prior written consent of the City, except that verbal Change Orders may be authorized in emergency situations as defined herein.

10.4 WAIVER:

The Contractor hereby waives any compensation for any change performed in the work which is not authorized as provided for herein.

11.0 PAYMENTS

11.1 APPLICATION FOR PARTIAL PAYMENTS; WAIVERS:

The Contractor shall submit to the City applications for payment for work performed and materials incorporated in the work during the month, prior to the last day of the month following the month in which such work was performed. Such applications shall be accompanied by waivers or the equivalent from suppliers of work or materials stating that such work or materials have been paid for by the Contractor. By submitting an application for payment, the Contractor warrants that all employees, sub-contractors, and materialmen have been paid to date for the labor and materials contained in the application.

11.2 PAYMENT OF EMPLOYEES; PREVAILING WAGE RATES:

The Contractor, and its subcontractors, shall comply with the Prevailing Wage Act (820 ILCS 130/1 et seq.), as amended. The Contractor, and each subcontractor, shall keep, or cause to be kept, an accurate record showing the names and occupation of all laborers, workers and mechanics employed by the Contractor or its subcontractors, in connection with the Work and showing the actual hourly wages paid to each such person. The submittal of an invoice or payment request to the City shall constitute the Contractor's certification to the City that all the wages paid for the work covered by the invoice or payment request have been paid in compliance with the Prevailing Wage Act. Upon the written request of the City, the Contractor, and its subcontractors, shall provide a complete and accurate copy of the records establishing compliance with the Prevailing Wage Act and this paragraph.

This contract calls for the construction of a "public work," within the meaning of the Illinois Prevailing Wage Act, 820 ILCS 130/01 *et. seq.* ("the Act"). The Act requires contractors and subcontractors to pay laborers, workers and mechanics performing services on public works projects no less than the "prevailing rate of wages" (hourly cash wages plus fringe benefits) in the county where the work is performed. For information regarding current prevailing wage rates, please refer to the Illinois Department of Labor's website at: <http://www.state.il.us/agency/idol/rates/rates.HTM>. All contractors and subcontractors rendering services under this contract must comply with all requirements of the Act, including but not limited to, all wage, notice and record keeping duties.

It is the responsibility of the contractor to check the above mentioned website for the most up to date wages for that month in which the work has taken place and to pay accordingly. Further, it is the responsibility of the contractor to supply the City of Joliet with certified payrolls for all work related to this contract. If you are unsure as to what a certified payroll sheet is that must be supplied, you may find one at the above mentioned website.

11.3 PARTIAL PAYMENTS BY THE CITY:

No later than forty-five (45) days following the submission of the application for payment, the City shall pay to the Contractor for the amount of the work contained in the application which has been found by the City to have been actually performed less ten percent (10%) of such amount which shall be retained until final payment less other deductions authorized to be retained by other sections of these General Conditions.

11.4 FINAL PAYMENT:

After final inspection by the City, the Contractor shall prepare his application for Final Payment and submit it to the City for approval. The application for Final Payment shall contain the total cost of the work as set forth in the proposal less all previous payments to the Contractor and be adjusted by the cost of all authorized Change Orders. Such application shall have attached thereto final lien waivers or the equivalent for all labor and materials incorporated into the work from all persons having supplied labor and materials under this contract. The City shall pay to the Contractor, not later than forty-five (45) days after such application is made, the amount which the City finds to be due and owing less deductions authorized by these General Conditions.

11.5 NO WAIVERS:

Neither by partial or final payment will the City be deemed to have waived any remedy for defective work or negligence on the part of the Contractor or any other portion of the contract which by its nature survives the time of Final Payment.

12.0 ADDITIONAL REQUIREMENTS:

In addition to any other requirement, unless otherwise expressly stated in a bid solicitation or an award of contract, all bidders must comply with the following requirements in order to submit a bid or be awarded a contract and include satisfactory evidence thereof in its bid.

- (a) The bidder shall be a duly organized legal entity in good standing with the Illinois Secretary of State and in compliance with all laws prerequisite to doing business in Illinois.
- (b) The bidder shall have a valid Federal Employer Tax Identification Number or Social Security Number.
- (c) The bidder shall be an equal opportunity employer and comply with Section 2000(e) of Chapter 21, Title 42 of the United States Code and Executive Order No. 11246.
- (d) The bidder shall provide certificates of insurance indicating the following coverages if called for in the bid solicitation: general liability, workers compensation, completed operations, automobile, hazardous occupation and product liability.
- (e) The bidder shall comply with all provisions of the Illinois Prevailing Wage Act (820 ILCS 130), including wages, medical and hospitalization insurance and retirement for those trades covered in the Act.
- (f) All contractors and sub-contractors performing services covered by the Illinois Prevailing Wage Act shall submit to the City the certified payrolls required by the Act, as amended by Illinois Public Act 94-0515.
- (g) For construction projects (construction of new facilities, renovation of existing facilities or road construction projects) over \$25,000.00, the bidder must provide apprenticeship and training programs that are either registered with the United States Department of Labor's Bureau of Apprenticeship and Training or are reasonably equivalent to such programs.

CITY OF JOLIET

2015 SUPPLEMENTAL SPECIAL PROVISIONS

The following Supplemental Special Provisions supplement the City of Joliet Special Provisions and General Conditions adopted January 1, 2013 and the "Standard Specifications for Road and Bridge Construction," adopted January 1, 2012 and the latest edition of the "Manual on Uniform Traffic Control Device for Streets and Highways," and the "Standard Specifications for Water and Sewer Main Construction in Illinois," in effect on the date of invitation for bids. In case of conflict with any parts of said specifications, the said Supplemental Special Provisions shall take precedence and shall govern. The above named publications shall hereinafter be referred to as the "Standard Specifications" which apply to and govern the construction of the **BETHEL/DOUGLAS/KUNGS/WALSH WATER MAIN IMPROVEMENT PROJECT – 2016**

1. LOCATION OF THE IMPROVEMENTS:

Bethel Drive from Black Road to Walsh Way, Douglas Street from Terry Drive to Westnedge Road, Kungs Way from Bethel Drive to Walsh Way, and Walsh Way from Bethel Drive to Kungs Way.

2. DESCRIPTION OF THE IMPROVEMENTS:

These improvements shall include the installation of ductile iron water main of various sizes, hot mix asphalt removal & replacement 4", water service connections, restoration and other water main related items.

3. PROJECT SCHEDULE:

This contract allows for 60 working days. All work shall be completed within this allotted period of time. If the contractor cannot meet this time constraint an extension may be granted, if justified, by a Formal request for Extension that shall be submitted for approval.

4. DUCTILE IRON WATERMAIN (Revised 04/23/15):

All water main materials incorporated into the City of Joliet water system, from the main line to the curb stop including fittings, shall be of Domestic Manufacture (i.e. manufactured within the United States) and shall meet all applicable specifications of the American Water Works Association (AWWA). Watermains shall be constructed of ductile iron pipe conforming to AWWA Specifications-21.51 with push-on joints conforming to AWWA Specifications A21.11. Pipe shall be thickness Class 52 with the following minimum wall thicknesses:

Nominal Pipe Size		Wall Thickness
6 Inch		0.31 Inch
8 Inch		0.33 Inch
10 Inch	32	0.35 Inch

12 Inch
16 Inch

0.37 Inch
0.40 Inch

Cement lining shall be applied in accordance with AWWA Specification C-104. All fittings shall be ductile iron compact mechanical joint rated for 350 PSI and conform to ASA A21.53 or AWWA C153. All fittings shall have ductile iron set screw type retainer glands conforming to ASA A21.53 or AWWA C153 and rubber gaskets conforming to ASA A21.11 or AWWA C111. Pipe shall be laid with five (5) foot minimum cover.

Unless otherwise shown on the plans, polyethylene protective wrapping (Polywrap) for ductile iron pipe shall be furnished and installed on all buried water lines, except where water lines within steel casing pipe, in accordance with the requirements of AWWA Standard C105. Polywrap shall be installed so as to prevent any section of the pipe, fittings, valves, services, or appurtenances from contacting the soil. The Polywrap shall be taped to provide a snug fit along the pipe. Any punctures, tears or other damage shall be patched with polyethylene wrap and tape. Openings for service taps, blowoffs, or similar appurtenances shall be cut in the polywrap during backfillings of the trench. Rock or other material that could damage the wrapping shall not be allowed in the backfill.

The polywrap furnished and installed shall not be paid separately, but shall be considered incidental to the cost of the ductile iron watermain.

All ductile iron water main pipes shall have brass wedges inserted at all joints for continuity to allow surface tracing by pipe locator.

Basis of Payment:

Watermain shall be listed in the bid items by size and type which shall be measured in lineal feet, slope measurement, along the center without deduction for valves and fittings. Embedment up to one foot above the pipe shall be included in the cost per lineal feet of watermain. **All fittings shall be included in the cost per lineal foot of watermain unless otherwise noted on the plans.** Additional fittings not anticipated shall be paid for as miscellaneous fittings measured in pounds. When the watermain terminates in a hydrant, valve or other main connection, measurement shall be from the center of the hydrant valve or main connection. This item shall be paid for at the contract unit price per lineal foot for DUCTILE IRON WATERMAIN of the type and size specified.

5. FIRE HYDRANT COMPLETE WITH AUXILIARY VALVE (Rev. 08/26/11):

Fire hydrants shall conform to AWWA C502-85. All hydrants shall be furnished with 6-inch flanged connections. All hydrants shall have a 5 ¼-inch valve opening; open left. All hydrants shall be provided with one 4 ½-inch NST steamer connection and two 2 ½-inch NST hose connections. Hydrants shall be painted red. One-quarter cubic yard of coarse, washed, glacial gravel shall be placed at the base of the hydrant to provide for drainage.

Fire hydrants shall be measured for payment as an installed unit complete with accessories. Accessories include a 3 3/8-inch gate valve and valve box connected

between the watermain and the fire hydrant. This work shall also include any vertical adjustment required to position the center of the steamer nozzle at least 18 inches above ground level. The hydrant shall be installed with traffic flange positioned as per manufacturer's installation instructions. Hydrants shall be Mueller Centurion A423 or Clow Medallion or E.J.I.W. 5BR250. All fire hydrants shall be new, manufactured either in the year that construction begins or the previous year.

Basis of Payment:

This work shall be paid for at the contract unit price each for FIRE HYDRANT COMPLETE WITH AUXILIARY VALVE and shall include all materials, equipment and labor necessary to install the fire hydrant and trench backfill at least one foot above the top of the pipe and hydrant.

**CITY OF JOLIET
SPECIAL PROVISIONS CHECKLIST
CAPITAL IMPROVEMENT/NEIGHBORHOOD IMPROVEMENT PROGRAM PROJECTS**

****SEE CITY OF JOLIET SPECIAL PROVISION BOOK**

<u>REQ.</u>	<u>NO.</u>	<u>SPECIFICATION TITLE</u>
<u> X </u>	1	TIMELINESS OF WORK
<u> X </u>	2	PREMIUM TIME
<u> X </u>	3	EXISTING UTILITIES
<u> X </u>	4A	MINORITY EMPLOYMENT REQUIREMENTS (+\$100,000)
<u> </u>	4B	MINORITY EMPLOYMENT REQUIREMENTS (<\$100,000)
<u> X </u>	5	STRUCTURE PROTECTION
<u> X </u>	6	PROTECTION OF PROPERTY & SURFACE STRUCTURES
<u> X </u>	7	INTERRUPTION TO UTILITIES
<u> X </u>	8	WORK TO BE DONE BY OTHERS
<u> X </u>	9	STREETLIGHTING
<u> X </u>	10	OVERHAUL
<u> X </u>	11	REMOVING & RESETTING STREET SIGNS
<u> </u>	12	WIDTH OF EXCAVATION OF STORM SEWERS
<u> </u>	13	CONSTRUCTION LAYOUT STAKES
<u> </u>	14	CITY PROVIDED STONE
<u> </u>	15	TREE ROOT SAWING
<u> </u>	16	HEDGE REMOVAL & REPLACEMENT
<u> </u>	17	EARTH EXCAVATION – SPECIAL
<u> </u>	18	PARKWAY EXCAVATION
<u> </u>	19	ROADWAY EXCAVATION
<u> </u>	20	REMOVAL & DISPOSAL UNSUITABLE MATERIAL
<u> </u>	21	POROUS GRANULAR EMBANKMENT, SPECIAL
<u> X </u>	22	TRENCH BACKFILL
<u> </u>	23	AGGREGATE BASE COURSE
<u> </u>	24	AGGREGATE BASE COURSE, TYPE B, VAR. THICKNESS
<u> </u>	25	AGGREGATE BASE COURSE, TYPE B, SPECIAL (2" and less)
<u> </u>	26	REPAIR & PREPARATION OF BASE COURSE
<u> </u>	27	PREPARATION OF BASE (ALLEYS)

**CITY OF JOLIET
SPECIAL PROVISIONS CHECKLIST
CAPITAL IMPROVEMENT/NEIGHBORHOOD IMPROVEMENT PROGRAM PROJECTS**

****SEE CITY OF JOLIET SPECIAL PROVISION BOOK**

<u> </u> X <u> </u>	28	STORM SEWERS
<u> </u>	29	DUCTILE IRON PIPE FOR STORM SEWER
<u> </u>	30	PVC (POLY VINYL CHLORIDE, SS, SDR 35) STORM SEWER
<u> </u> X <u> </u>	31	STORM SEWER REMOVAL
<u> </u>	32	REMOVE AND RELAY STORM SEWERS
<u> </u> X <u> </u>	33	TAPPING VALVES AND SLEEVES
<u> </u> X <u> </u>	34	DUCTILE IRON WATERMAIN
<u> </u> X <u> </u>	35	GATE VALVES
<u> </u> X <u> </u>	36	WATER SERVICE CONNECTION
<u> </u> X <u> </u>	37	WATER SERVICE LINE
<u> </u> X <u> </u>	38	MISCELLANEOUS FITTINGS
<u> </u>	39	ADJUSTING WATER SERVICE LINES
<u> </u>	40	ADJUSTING WATERMAIN
<u> </u>	41	DISCONNECTING OF EXISTING WATER LINE
<u> </u>	42	DUCTILE IRON FORCEMAIN
<u> </u>	43	SANITARY SEWER REPLACEMENT, DUCTILE IRON PIPE
<u> </u>	44	SANITARY SERVICE REPLACEMENT (CASE I & II)
<u> </u>	45	RESTRAINED JOINTS
<u> </u>	46	JUNCTION CHAMBERS
<u> </u>	47	CATCH BASIN/INLET TO BE REMOVED
<u> </u>	48	CATCH BASIN/INLET TO BE RELOCATED
<u> </u>	49	MANHOLE / VALVE VAULT TO BE ADJUSTED
<u> </u>	50	MANHOLES
<u> </u>	51	MANHOLE TO BE ADJUSTED (SPECIAL)
<u> </u>	52	FRAME & GRATE TO BE FURNISHED & INSTALLED
<u> </u>	53	FRAMES & LIDS
<u> </u>	54	TYPE 11 FRAME & GRATE (SPECIAL)
<u> </u>	55	TYPE 11 FRAME & GRATE (VANED)
<u> </u>	56	COMBINATION CONCRETE CURB & GUTTER

CITY OF JOLIET
SPECIAL PROVISIONS CHECKLIST
CAPITAL IMPROVEMENT/NEIGHBORHOOD IMPROVEMENT PROGRAM PROJECTS

**SEE CITY OF JOLIET SPECIAL PROVISION BOOK

<input type="checkbox"/>	57	FINE GRADING BENEATH THE CURB
<input type="checkbox"/>	58	HAND FORMED CURB
<input checked="" type="checkbox"/>	59	COMBINATION CONC. CURB & GUTTER REMOVAL & REPLMT
<input checked="" type="checkbox"/>	60	SIDEWALK REMOVAL & REPLACEMENT
<input type="checkbox"/>	61	CURB REMOVAL – SPECIAL
<input checked="" type="checkbox"/>	62	DRIVEWAY PAVEMENT REMOVAL & REPLACEMENT
<input checked="" type="checkbox"/>	63	HOT MIX ASPHALT REMOVAL & REPLACEMENT
<input checked="" type="checkbox"/>	64	PORTLAND CEMENT CONCRETE DRIVEWAY PAVEMENT
<input checked="" type="checkbox"/>	65	PORTLAND CEMENT CONCRETE SIDEWALK
<input checked="" type="checkbox"/>	66	HOT MIX ASPHALT DRIVEWAY PAVEMENT
<input type="checkbox"/>	67	P.C.C. SIDEWALK STEP CONSTRUCTION
<input type="checkbox"/>	68	FENCE TO BE REMOVED AND RE-ERECTED
<input type="checkbox"/>	69	FIRE HYDRANT TO BE MOVED
<input checked="" type="checkbox"/>	70	FIRE HYDRANT COMPLETE W/AUXILIARY VALVE
<input type="checkbox"/>	71	FIRE HYDRANT COMPLETE W/O AUXILIARY VALVE
<input type="checkbox"/>	72	DOMESTIC WATER SERVICE BOXES – RELOCATED
<input type="checkbox"/>	73	DOMESTIC WATER SERVICE BOXES – ADJUSTED
<input checked="" type="checkbox"/>	74	FIRE HYDRANT TO BE REMOVED
<input type="checkbox"/>	75	WATERMAIN PROTECTION
<input checked="" type="checkbox"/>	76	FURNISHING & PLACING TOPSOIL
<input checked="" type="checkbox"/>	77	SEEDING, TYPE 1A W/MULCH, METHOD A
<input type="checkbox"/>	78	HYDRAULIC SEEDING
<input type="checkbox"/>	79	SODDING
<input type="checkbox"/>	80	HARDWOOD MULCH
<input type="checkbox"/>	81	TREES TO BE PLANTED
<input checked="" type="checkbox"/>	82	TRAFFIC CONTROL & PROTECTION
<input type="checkbox"/>	83	CONTRACTOR SUPPLIED LABOR
<input type="checkbox"/>	84	EQUIPMENT RENTAL
<input type="checkbox"/>	85	PROJECT SIGN

CITY OF JOLIET
SPECIAL PROVISIONS CHECKLIST
CAPITAL IMPROVEMENT/NEIGHBORHOOD IMPROVEMENT PROGRAM PROJECTS

****SEE CITY OF JOLIET SPECIAL PROVISION BOOK**

<u> </u> X	86	SAWCUT ASPHALT SURFACE
<u> </u> X	87	SAWCUT CONCRETE SURFACE
<u> </u>	88	ASPHALT/CONCRETE SAWING
<u> </u>	89	TIMBER RETAINING WALL
<u> </u>	90	TIMBER RETAINING WALL – REMOVED/RE-ERECTED
<u> </u>	91	HOT MIX ASPHALT REMOVAL AREA/SPECIAL
<u> </u>	92	HOT MIX ASPHALT SURFACE REMOVAL- VARIABLE DEPTH
<u> </u>	93	FULL DEPTH PATCHING
<u> </u>	94	APPLICATION OF BITUMINOUS MATERIAL/PRIME COAT
<u> </u>	95	SURFACE TESTS
<u> </u>	96	AREA REFLCT CRACK CONTROL TREATMENT/SYSTEM A
<u> </u>	97	DETECTOR LOOP REPLACEMENT
<u> </u>	98	MAGNETIC DETECTOR REMOVAL AND DETECTOR LOOP INSTALLATION
<u> </u>	99	NOTIFICATION OF RESIDENTS
<u> </u>	100	CSO CHAMBER REMOVAL
<u> </u>	101	RAILS TO BE REMOVED
<u> </u>	102	MOBILIZATION
<u> </u>	103	TEMPORARY DRIVEWAY ACCESS
<u> </u>	104	MODULAR CONCRETE BLOCK RETAINING WALL
<u> </u>	105	LATE SIDEWALK REMOVAL
<u> </u>	106	MANHOLE REHABILITATION
<u> </u>	107	SUMP LINE CONNECTIONS
<u> </u>	108	CLEAN OUT STRUCTURE
<u> </u>	109	MAILBOX PROTECTION / RELOCATION
<u> </u>	110	CARRIAGE STONES TO BE PROTECTED
<u> </u>	111	SIDEWALK TILES TO BE SALVAGED
<u> </u>	112	SIDEWALK TILE INSTALLATION
<u> </u>	113	STREETSCAPE BRICK REMOVE AND REPLACE
<u> </u>	114	TRAFFIC CONTROL AND PERMITS
<u> </u>	115	EROSION CONTROL
<u> </u>	116	DRIVEWAY PAVEMENT REMOVAL
<u> </u> X	117	PARTIAL PAYMENTS & RETAINAGE
<u> </u>	118	MATERIAL INSPECTION

CITY OF JOLIET
SPECIAL PROVISIONS CHECKLIST
CAPITAL IMPROVEMENT/NEIGHBORHOOD IMPROVEMENT PROGRAM PROJECTS

****SEE CITY OF JOLIET SPECIAL PROVISION BOOK**

<input type="checkbox"/>	119	VALVE BOX TO BE ADJUSTED
<input type="checkbox"/>	120	FRAMES AND LIDS TO BE FURNISHED AND INSTALLED
<input type="checkbox"/>	121	STRUCTURE TO BE ADJUSTED
<input checked="" type="checkbox"/>	122	TESTING FOR CONTAMINATED MATERIAL
<input type="checkbox"/>	123	REMOVAL AND DISPOSAL OF CONTAMINATED MATERIAL

ADJUSTMENT ITEMS	EX	PR	ALIGNMENT ITEMS	EX	PR	CONTOUR ITEMS	EX	PR
Structure To Be Adjusted		ADJ	Baseline			Approx. Index Line		
Structure To Be Cleaned		C	Centerline			Approx. Intermediate Line		
Mdn Structure To Be Filled		FM	Centerline Break Circle	○	○	Index Contour		
Structure To Be Filled		F	Baseline Symbol	⊕	⊕	Intermediate Contour		
Structure To Be Filled Special		FSP	Centerline Symbol	⊕	⊕	Channel or Stream Line		
Structure To Be Removed		R	PI Indicator	△	△	Culvert Line		
Structure To Be Reconstructed		REC	Point Indicator	○	○	Grading & Shaping Ditches		
Structure To Be Reconstructed Special		RSP	Horizontal Curve Data (Half Size)	CURVE P.I. STA: Δ DE TE LE BE T.P.S. P.C. STA: P.T. STA:	CURVE P.I. STA: Δ DE TE LE BE T.P.S. P.C. STA: P.T. STA:	Drainage Boundary Line		
Frame and Grate To Be Adjusted		A	BOUNDARIES ITEMS			Paved Ditch		
Frame and Lid To Be Adjusted		A	Dashed Property Line	---	---	Aggregate Ditch		
Domestic Service Box To Be Adjusted		A	Solid Property/Lot Line	---	---	Pipe Under-drain		
Valve Vault To Be Adjusted		A	Section/Grant Line	---	---	Storm Sewer		
Special Adjustment		SP	Quarter Section Line	---	---	Flowline		
Item To Be Abandoned		AB	Quarter/Quarter Section Line	---	---	Ditch Check		
Item To Be Moved		M	County/Township Line	---	---	Headwall		
Item To Be Relocated		REL	State Line	---	---	Inlet		
Pavement Removal and Replacement			Iron Pipe Found	○	○	Manhole		
			Iron Pipe Set	●	●	Summit		
			Survey Marker	⊕	⊕	Roadway Ditch Flow		
			Property Line Symbol	⊕	⊕	Swale		
			Same Ownership Symbol (Half Size)	⊕	⊕	Catch Basin		
			Northwest Quarter Corner (Half Size)	⊕	⊕	Culvert End Section		
			Section Corner (Half Size)	⊕	⊕	Water Surface Indicator		
			Southeast Quarter Corner (Half Size)	⊕	⊕	Riprap		

**STANDARD SYMBOLS,
ABBREVIATIONS
AND PATTERNS**
(Sheet 2 of 8)

STANDARD 000001-06

Illinois Department of Transportation
 PASSED January 1, 2011
 ENGINEER OF POLICY AND PROCEDURES
 APPROVED January 1, 2011
 ENGINEER OF DESIGN AND ENVIRONMENT

EROSION & SEDIMENT CONTROL ITEMS	NON-HIGHWAY IMPROVEMENT ITEMS	EXISTING LANDSCAPING ITEMS (contd.)	LIGHTING
Cleaning & Grading Limits	Noise Attn./Levee	Seeding Class 5	Duct
Dike	Field Line	Seeding Class 7	Conduit
Erosion Control Fence	Fence	Seedlings Type 1	Electrical Aerial Cable
Perimeter Erosion Barrier	Base of Levee	Seedlings Type 2	Electrical Buried Cable
Temporary Fence	Mulchbox	Sodding	Controller
Ditch Check Temporary	Multiple Mailboxes	Mowstake w/Sign	Underpass Luminaire
Ditch Check Permanent	Pay Telephone	Tree Trunk Protection	Power Pole
Inlet & Pipe Protection	Advertising Sign	Evergreen Tree	
Sediment Basin		Shade Tree	
Erosion Control Blanket	LANDSCAPING ITEMS		
Fabric Formed Concrete Reinforcement Mat	Contour Mounding Line		
Turf Reinforcement Mat	Fence		
Mulch Temporary	Fence Post		
Mulch Method 1	Shrubs		
Mulch Method 2 Stabilized	Mowline		
Mulch Method 3 Hydraulic	Perennial Plants		
	Seeding Class 2		
	Seeding Class 2A		
	Seeding Class 4		
	Seeding Class 4 & 5 Combined		

STANDARD SYMBOLS, ABBREVIATIONS AND PATTERNS
(Sheet 3 of 8)
STANDARD 000001-06

Illinois Department of Transportation
PASSED JANUARY 11, 2011
ENGINEER OF PROJECT AND PROCEDURES
APPROVED JANUARY 11, 2011
ENGINEER OF DESIGN AND ENVIRONMENT

LIGHTING
(contd.)

Pull Point

Handhole

Heavy Duty Handhole

Junction Box

Light Unit Comb.

Electrical Ground

Traffic Flow Arrow

High Mast Pole
(Half Size)

Light Unit-1

EX



PR



PAVEMENT (MISC.)

Keyed Long. Joint

Keyed Long. Joint w/Tie Bars

Sowed Long. Joint w/Tie Bars

Bituminous Shoulder

Bituminous Taper

Stabilized Driveway

Widening

EX



PAVEMENT MARKINGS

Bike Lane Symbol

Bike Lane Text

Handicap Symbol

RR Crossing

Raised Marker Amber 1 Way

Raised Marker Amber 2 Way

Raised Marker Crystal 1 Way

Two Way Turn Left

Shoulder Diag. Pattern

Skip-Dash White

Skip-Dash Yellow

Stop Line

Solid Line

Double Centerline

Dotted Lines

CL 2Ln 2Way
RRPM 12.2 m (40') o.c.

CL 2Ln 2Way
RRPM 80' (24.4 m) o.c.

CL Multilane Div.
RRPM 40' (12.2 m) o.c.

CL Multilane Div.
RRPM 80' (24.4 m) o.c.

CL Multilane Div. Dbl.
RRPM 80' (24.4 m) o.c.

CL Multilane Undiv.

Two Way Turn Left Line

EX



PR

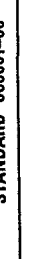
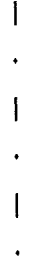
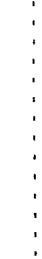
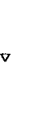
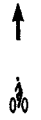

**STANDARD SYMBOLS,
ABBREVIATIONS
AND PATTERNS**

(Sheet 4 of 8)

STANDARD 060001-06

Illinois Department of Transportation
PASSED JANUARY 11, 2011
ENGINEER OF PRACTICE AND PROCEDURES
APPROVED JANUARY 11, 2011
ENGINEER OF DESIGN AND ENVIRONMENT

ISSUED 1-1-97

PAVEMENT MARKINGS
(contd.)

- Urban Combination Left
- Urban Combination Right
- Urban Left Turn Arrow
- Urban Right Turn Arrow
- Urban Left Turn Only
- Urban Right Turn Only
- Urban Thru Only
- Urban U-Turn
- Urban Combined U-Turn
- Rural Combination Left
- Rural Combination Right
- Rural Left Turn Arrow
- Rural Right Turn Arrow
- Rural Left Turn Only
- Rural Right Turn Only
- Rural Thru Only

EX

PR

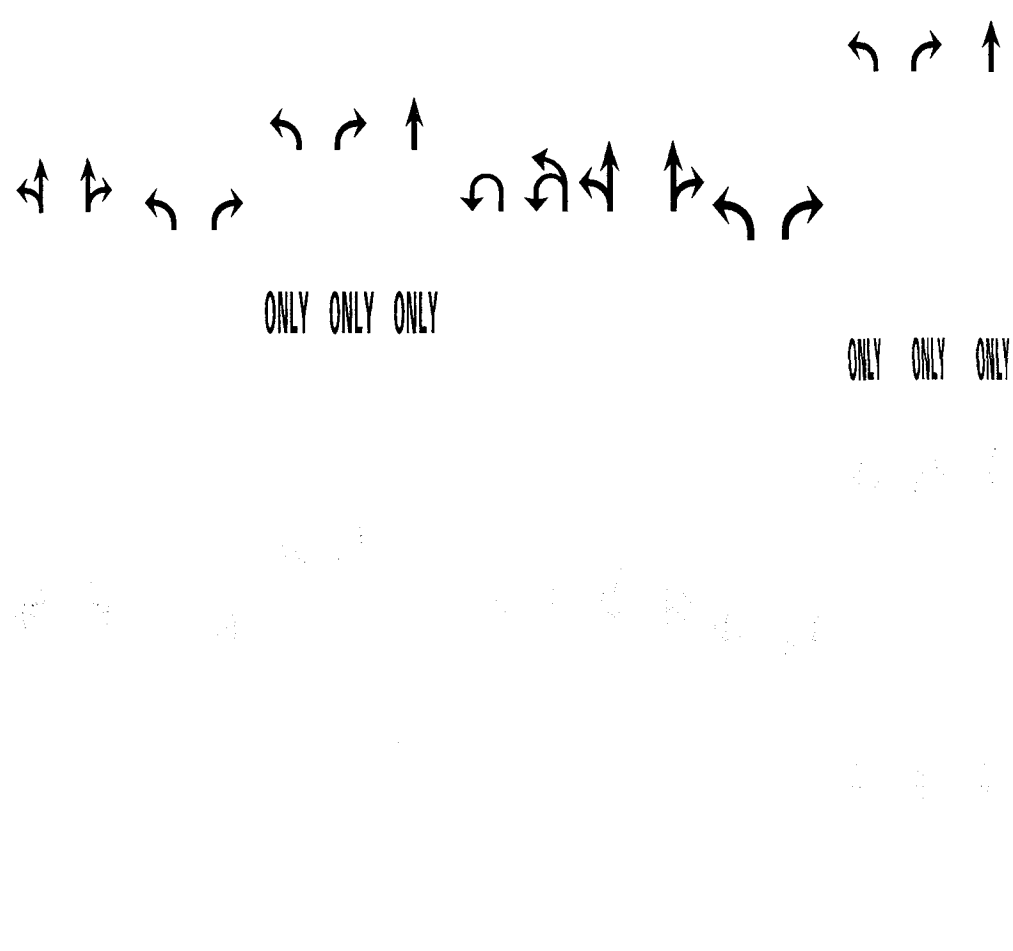

RAILROAD ITEMS

- Abandoned Railroad
- Railroad
- Railroad Point
- Control Box
- Crossing Gate
- Fleeting Signal
- Railroad Cont. Mast Arm
- Crossbuck

PR

EX

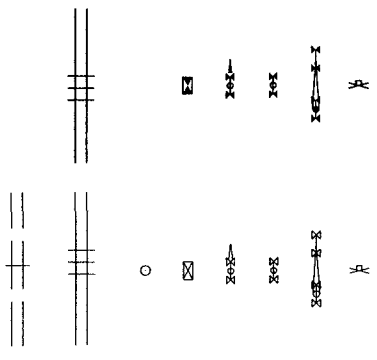

REMOVAL ITEMS

- Removal Tic
- Bituminous Removal
- Hatch Pattern
- Tree Removal Single

EX

PR

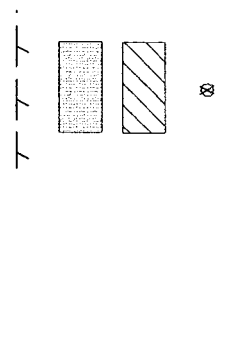

RIGHT OF WAY ITEMS

- Future ROW Corner Monument
- ROW Marker
- ROW Line
- Easement
- Temporary Easement

EX

PR

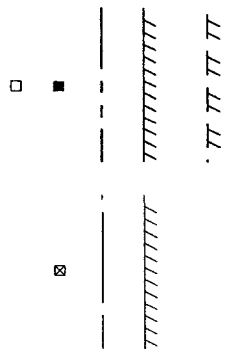

STANDARD SYMBOLS, ABBREVIATIONS AND PATTERNS
(Sheet 5 of 8)
STANDARD 000001-06

Illinois Department of Transportation
 PASSED January 1, 2011
 ENGINEER OF POLICY AND PROCEDURES
 APPROVED January 1, 2011
 ENGINEER OF DESIGN AND ENVIRONMENT

ISSUED 1-1-97

<u>RIGHT OF WAY ITEMS</u> (contd.)	<u>EX</u>	<u>PR</u>	<u>ROADWAY PROFILES</u>	<u>EX</u>	<u>PR</u>	<u>SIGNING ITEMS</u> (contd.)	<u>EX</u>	<u>PR</u>
Access Control Line	— AC —	— AC —	P.L. Indicator	▲	▲	Reverse Left W1-4L (Half Size)	▲	
Access Control Line & ROW	— AC —	— AC —	Point Indicator	○	○	Reverse Right W1-4R (Half Size)	○	
Access Control Line & ROW with Fence	— AC —	— AC —	Earthworks Balance Point			Two Way Traffic Sign W6-3 (Half Size)		
Excess ROW Line	— XS —		Begin Point			Detour Ahead W20-2(O) (Half Size)		
<u>ROADWAY PLAN ITEMS</u>	<u>EX</u>	<u>PR</u>	Vert. Curve Data	VPI = ELEV = L = E =	VPI = ELEV = L = E =	Left Lane Closed Ahead W20-5(L)(O) (Half Size)		
Cable Barrier			Ditch Profile Left Side	— — — —	— — — —	Right Lane Closed Ahead W20-5(R)(O) (Half Size)		
Concrete Barrier			Ditch Profile Right Side	— — — —	— — — —	Road Closed Ahead W20-3(O) (Half Size)		
Edge of Pavement			Roadway Profile Line	— — — —	— — — —	Road Construction Ahead W20-1(O) (Half Size)		
Bit Shoulders, Medians and C&G Line			Storm Sewer Profile Left Side	— — — —	— — — —	Single Lane Ahead (Half Size)		
Aggregate Shoulder			Storm Sewer Profile Right Side	— — — —	— — — —	Transition Left W4-2L (Half Size)		
Sidewalks, Driveways			<u>SIGNING ITEMS</u>	<u>EX</u>	<u>PR</u>	Transition Right W4-2R (Half Size)		
Guardrail			Cone, Drum or Barricade	○	○			
Guardrail Post			Barricade Type II					
Traffic Sign			Barricade Type III					
Corrugated Median			Barricade With Edge Line					
Impact Attenuator			Flashing Light Sign					
North Arrow with District Office (Half Size)			Panels I					
Match Line	— STA. 45+00 —		Panels II					
Slope Limit Line			Direction of Traffic					
Typical Cross-Section Line			Sign Flag (Half Size)					

**STANDARD SYMBOLS,
ABBREVIATIONS
AND PATTERNS**
(Sheet 6 of 8)
STANDARD 000001-06

Illinois Department of Transportation
 PASSED January 1, 2011
 ENGINEER OF PUBLIC WORKS
 APPROVED January 1, 2011
 ENGINEER OF DESIGN AND ENVIRONMENT

ISSUED 1-1-97

<u>SIGNING ITEMS</u> (cont'd.)	<u>EX</u>	<u>PR</u>	<u>STRUCTURES ITEMS</u>	<u>EX</u>	<u>PR</u>	<u>TRAFFIC SHEET ITEMS</u>	<u>EX</u>	<u>PR</u>
One Way Arrow Lrg. W1-6-(0) (Half Size)			Box Culvert Barrel			Cable Number		
Two Way Arrow Large W1-7-(0) (Half Size)			Box Culvert Headwall			Left Turn Green		
Detour M4-10L-(0) (Half Size)			Bridge Pier			Left Turn Yellow		
Detour M4-10R-(0) (Half Size)			Bridge			Signal Backplate		
One Way Left R6-1L (Half Size)			Retaining Wall			Signal Section 8" (200 mm)		
One Way Right R6-1R (Half Size)			Temporary Sheet Piling			Signal Section 12" (300 mm)		
Left Turn Lane R3-1100L (Half Size)						Walk/Don't Walk Letters		
Keep Left R4-7AL (Half Size)						Walk/Don't Walk Symbols		
Keep Left R4-7BL (Half Size)								
Keep Right R4-7AR (Half Size)								
Keep Right R4-7BR (Half Size)								
Stop Here On Red R10-6-AL (Half Size)								
Stop Here On Red R10-6-AR (Half Size)								
No Left Turn R3-2 (Half Size)								
No Right Turn R3-1 (Half Size)								
Road Closed R11-2 (Half Size)								
Road Closed Thru Traffic R11-2 (Half Size)								

**STANDARD SYMBOLS,
ABBREVIATIONS
AND PATTERNS**
(Sheet 7 of 8)
STANDARD 000001-06

TRAFFIC SIGNAL ITEMS (contd.)

	EX	PR
Detector Raceway		
Aluminum Mast Arm		
Steel Mast Arm		
Veh. Detector Magnetic		
Conduit Splice		
Controller		
Curbbox Junction		
Wood Pole		
Temp. Signal Head		
Handhole		
Double Handhole		
Heavy Duty Handhole		
Junction Box		
Ped. Pushbutton Detector		
Ped. Signal Head		
Power Pole Service		
Priority Veh. Detector		
Signal Head		
Signal Head w/Backplate		
Signal Post		
Closed Circuit TV		
Video Detector System		

UNDERGROUND UTILITY ITEMS

	EX	PR	ABANDONED
Cable TV			
Electric Cable			
Fiber Optic			
Gas Pipe			
Oil Pipe			
Sanitary Sewer			
Telephone Cable			
Water Pipe			

UTILITIES ITEMS

	EX	PR
Controller		
Double Handhole		
Fire Hydrant		
GuyWire or Deadman Anchor		
Handhole		
Heavy Duty Handhole		
Junction Box		
Light Pole		
Manhole		
Pipeline Warning Sign		
Power Pole		
Power Pole with Light		
Sanitary Sewer Cleanout		
Splice Box Above Ground		
Telephone Splice Box Above Ground		
Telephone Pole		

UTILITY ITEMS (contd.)

	EX	PR
Traffic Signal		
Traffic Signal Control Box		
Water Meter		
Water Meter Valve Box		
Profile Line		
Aerial Power Line		

VEGETATION ITEMS

	EX	PR
Deciduous Tree		
Bush or Shrub		
Evergreen Tree		
Stump		
Orchard/Nursery Line		
Vegetation Line		
Woods & Bush Line		

WATER FEATURE ITEMS

	EX	PR
Stream or Drainage Ditch		
Waters Edge		
Water Surface Indicator		
Water Point		
Disappearing Ditch		
Marsh		
Marsh/Swamp Boundary		

STANDARD SYMBOLS, ABBREVIATIONS AND PATTERNS
(Sheet 8 of 8)
STANDARD 000001-06

Illinois Department of Transportation
PASSED January 1, 2011
ENGINEER OF TRAFFIC AND PROCEDURES
APPROVED January 1, 2011
ENGINEER OF DESIGN AND ENVIRONMENT

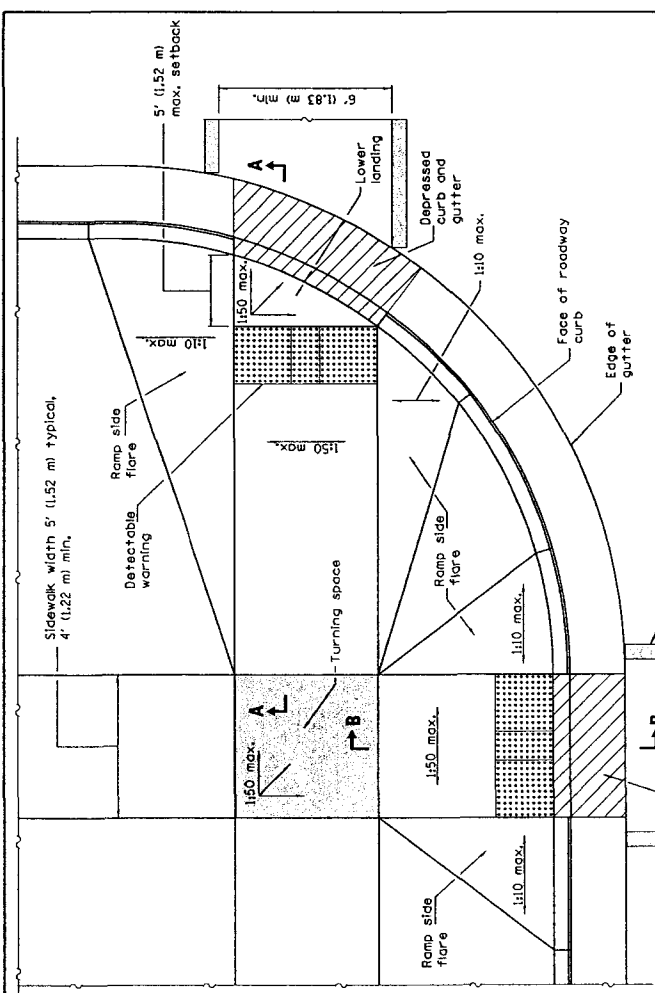

RAMPS IN LANSCAPED AREA
SETBACK ≤ 5'

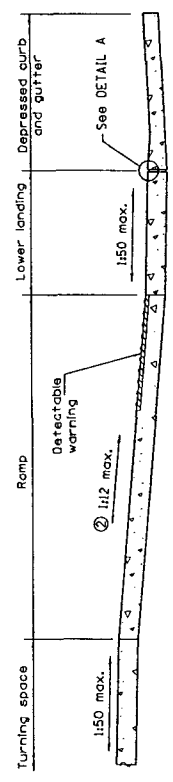

SECTION A-A

② The running slope of the curb ramp shall not require the ramp length to exceed 15' (4.5 m).

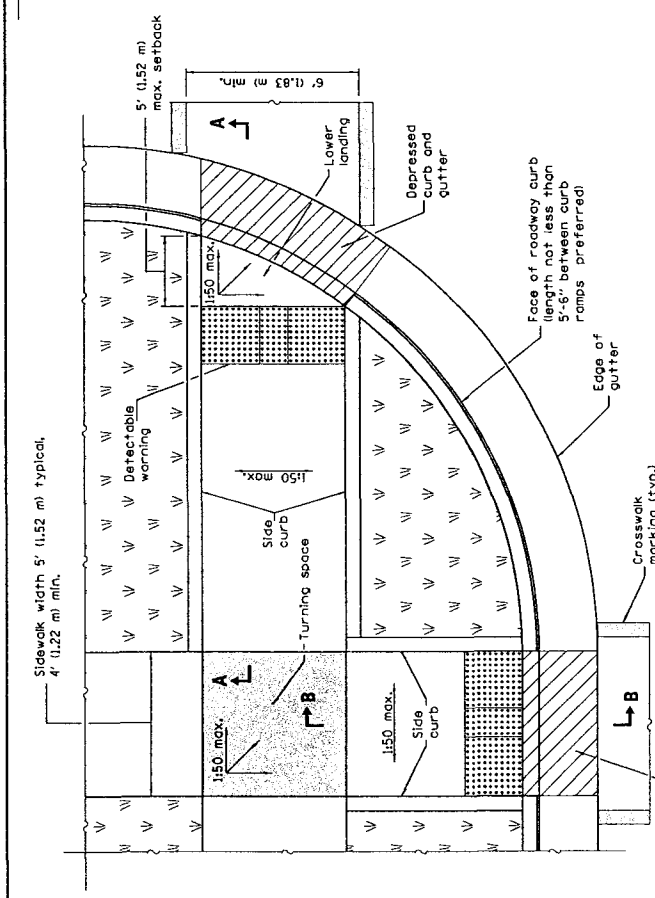

RAMPS IN PAVED AREA
SETBACK ≤ 5'

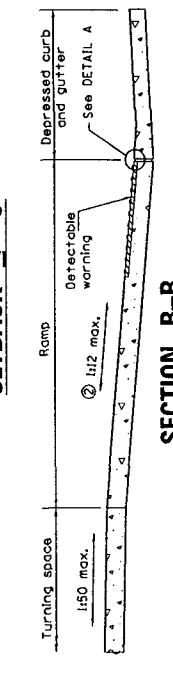

SECTION B-B

② The running slope of the curb ramp shall not require the ramp length to exceed 15' (4.5 m).

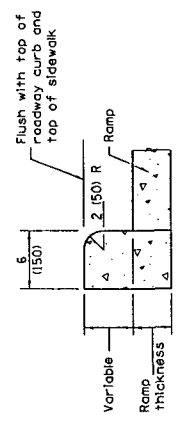

SIDE CURB DETAIL

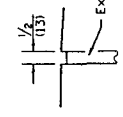

DETAIL A

See Sheet 2 for GENERAL NOTES.

PERPENDICULAR CURB RAMPS FOR SIDEWALKS
 (Sheet 1 of 2)

STANDARD 424001-08

DATE	REVISIONS
1-1-15	① not appl. to int. sidewalks, Rev. gen. notes, Ch'd Upper landing to Turning space.
1-1-13	② Wicened crosswalk markings to 6' (1.83 m) min. inside dimension, Rev. Gen. Notes.

ISSUED 1-1-97

Illinois Department of Transportation
 PASSED January 1, 2015
 ENGINEER OF POLICY AND PROCEDURES
 APPROVED January 1, 2015
 ENGINEER OF DESIGN AND ENVIRONMENT

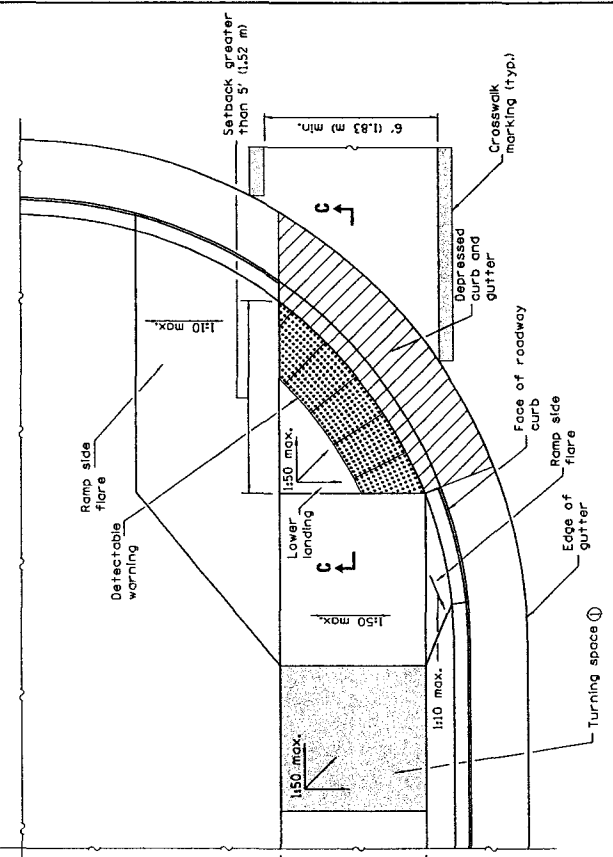

RAMP IN LANDSCAPED AREA
SETBACK > 5'

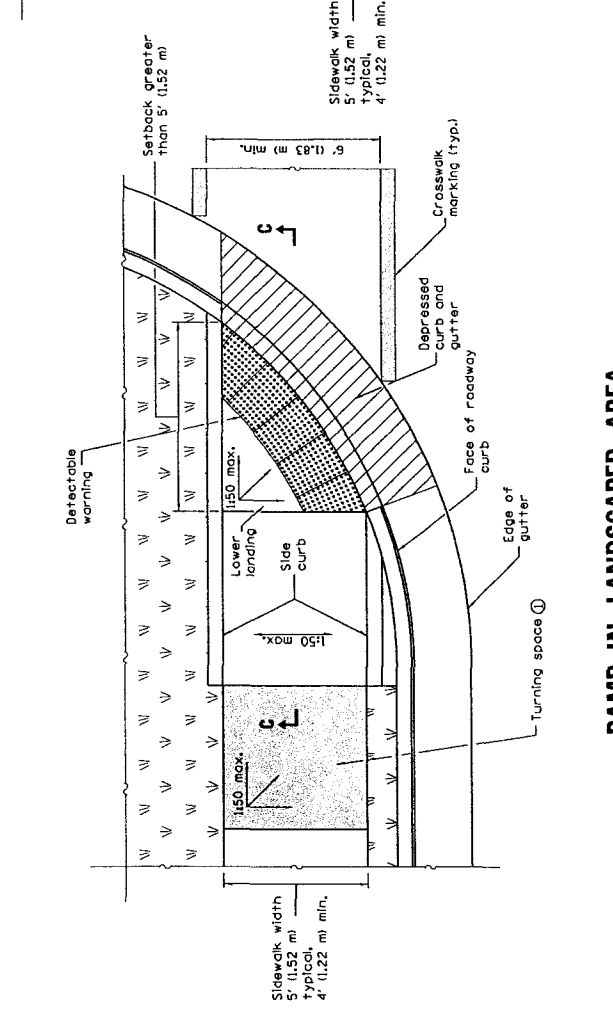

RAMP IN PAVED AREA
SETBACK > 5'

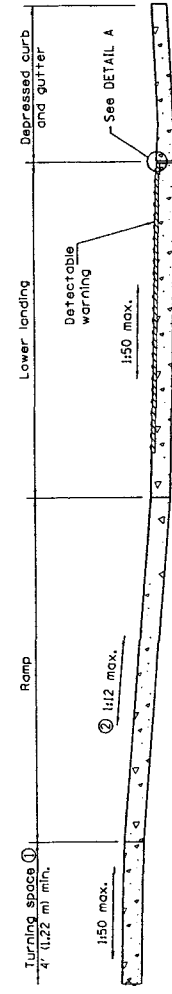

SECTION C-C

- ① Turning space not required for ramp slopes flatter than 1:20.
- ② The running slope of the curb ramp shall not require the ramp length to exceed 15' (4.5 m).

GENERAL NOTES
 All slope ratios are expressed as units of vertical displacement to units of horizontal displacement (V/H).
 Where the turning space is constrained on a side opposite a ramp, the minimum length of the turning space in the direction of the ramp-run shall be 5' (1.52 m).
 Where 1:50 maximum slope is shown, 1:64 is preferred.
 See Standard 606001 for details of depressed curb adjacent to curb ramp.
 All dimensions are in inches (millimeters) unless otherwise shown.

PERPENDICULAR CURB RAMPS FOR SIDEWALKS
 (Sheet 2 of 2)
STANDARD 424001-08

Illinois Department of Transportation
 PASSED: JUDYCHY J. 2015
 ENGINEER OF PUBLIC WORKS
 APPROVED: [Signature] 2015
 ENGINEER OF DESIGN AND ENVIRONMENT

ISSUED 1-1-97

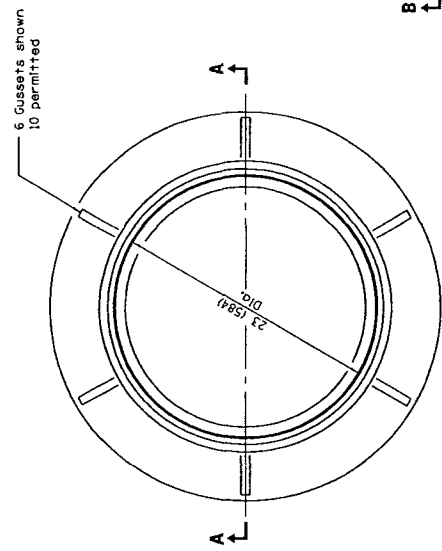

CAST FRAME

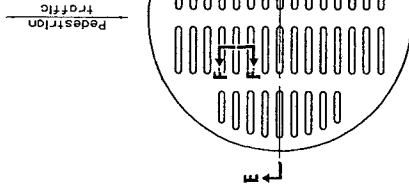

**ADA COMPLIANT
CAST OPEN LID**

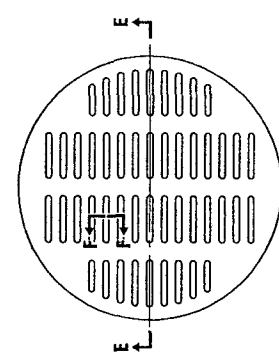

CAST CLOSED LID
Gray Iron Lid

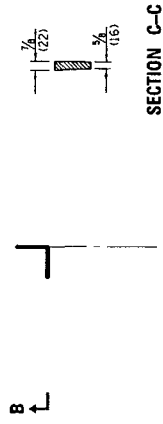

SECTION C-C

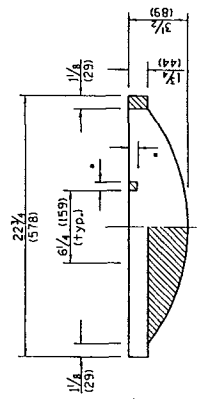

SECTION B-B

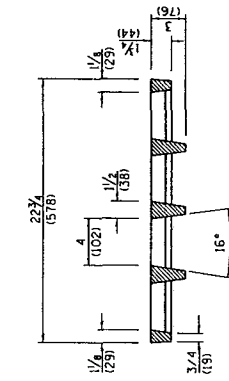

SECTION E-E

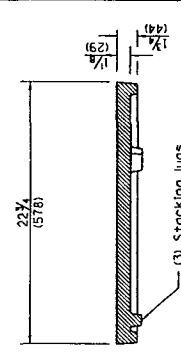

SECTION D-D

SECTION A-A
Gray Iron

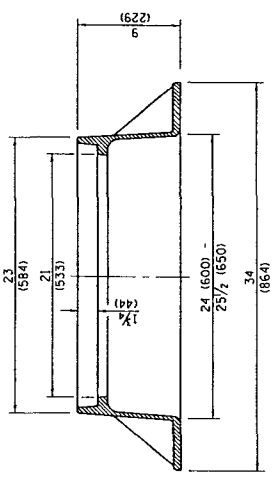

All dimensions are in inches (millimeters) unless otherwise shown.

REVISIONS	
DATE	REVISED
1-1-15	Revised dimensioning of Frame. Added ADA compliant open lid.
1-1-09	Switched units to English metric.

**FRAME AND LIDS
TYPE 1**

STANDARD 604001-04

Illinois Department of Transportation
 PASSED _____ JANSUARY 11, 2015
 ENGINEER OF SAFETY AND PROCEDURES
 APPROVED _____ JANSUARY 11, 2015
 ENGINEER OF DESIGN AND ENVIRONMENT

ISSUED 1-1-97

Doweled contraction joint
(Placed in prolongation with pavement joints)
construction option:

1. Form with 1/8" (3) thick steel template placed at mid-depth.
2. Saw at 4 to 24 hours, and seal.

Short radius curve
(shown as offsets,
side sets and
ramp returns).

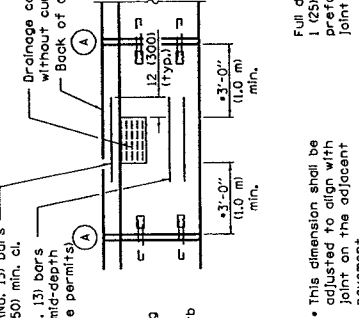
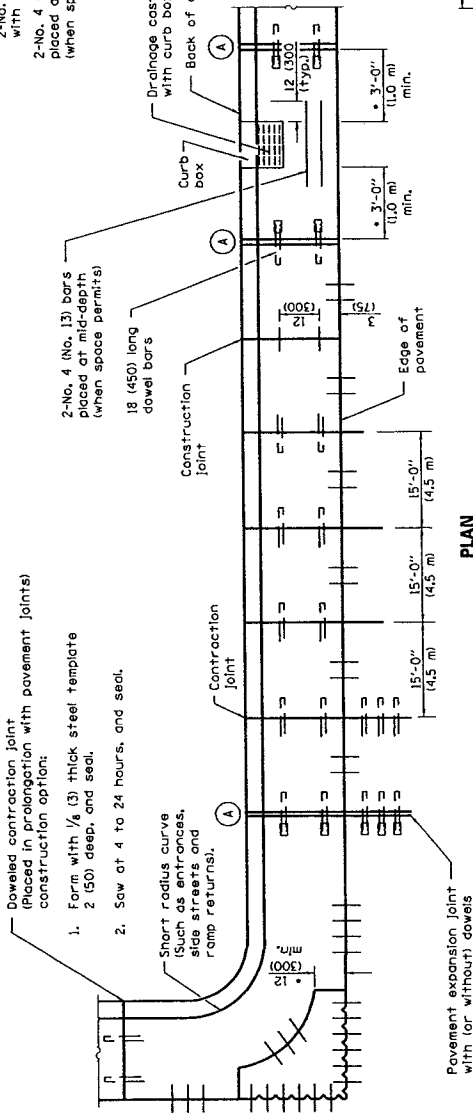

Full depth & width
1 (25) - thick (min.)
preformed expansion
joint filler.

Expansion
cap

18 (450) long dowel
bar placed at
mid-depth.

PLAN
ADJACENT TO PCC PAVEMENT OR PCC BASE COURSE

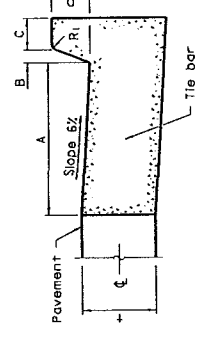
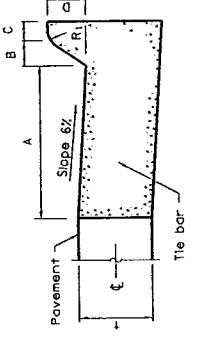

DEPRESSED CURB (TYPICAL)

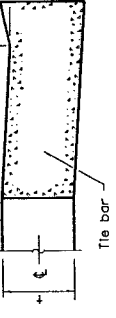

DEPRESSED CURB ADJACENT TO CURB RAMP ACCESSIBLE TO THE DISABLED

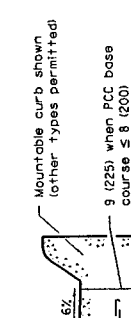

ADJACENT TO PCC BASE COURSE WITH HMA SURFACING

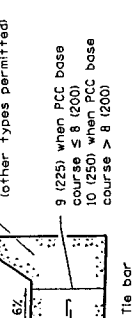

ADJACENT TO PCC BASE COURSE WITH HMA SURFACING

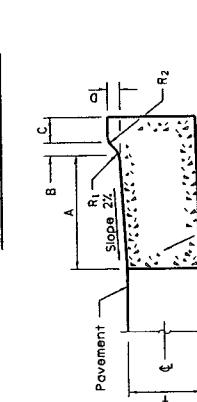

MOUNTABLE CURB

TABLE OF DIMENSIONS
MOUNTABLE CURB

TYPE	A	B	C	D	R1	R2
M-2.06	6	2	4	2	3	2
(M-5.15)	(150)	(50)	(100)	(50)	(75)	(50)
M-2.12	12	2	4	2	3	2
(M-5.30)	(300)	(50)	(100)	(50)	(75)	(50)
M-4.06	6	4	3	4	3	NA
(M-10.15)	(150)	(100)	(75)	(100)	(75)	NA
M-4.12	12	4	3	4	3	NA
(M-10.30)	(300)	(100)	(75)	(100)	(75)	NA
M-4.18	18	4	3	4	3	NA
(M-10.40)	(450)	(100)	(75)	(100)	(75)	NA
M-6.24	24	4	3	4	3	NA
(M-15.60)	(600)	(100)	(75)	(100)	(75)	NA
M-6.06	6	6	2	6	2	NA
(M-15.15)	(150)	(150)	(50)	(150)	(50)	NA
M-6.12	12	6	2	6	2	NA
(M-15.30)	(300)	(150)	(50)	(150)	(50)	NA
M-6.18	18	6	2	6	2	NA
(M-15.45)	(450)	(150)	(50)	(150)	(50)	NA
M-6.24	24	6	2	6	2	NA
(M-15.60)	(600)	(150)	(50)	(150)	(50)	NA

BARRIER CURB

TABLE OF DIMENSIONS
BARRIER CURB

TYPE	A	B	C	D	R1	R2
B-6.06*	6	1	6	6	1	
(B-15.15)	(150)	(25)	(150)	(150)	(25)	
B-6.12	12	1	6	6	1	
(B-15.3)	(300)	(25)	(150)	(150)	(25)	
B-6.18	18	1	6	6	1	
(B-15.45)	(450)	(25)	(150)	(150)	(25)	
B-6.24	24	1	6	6	1	
(B-15.60)	(600)	(25)	(150)	(150)	(25)	
B-5.12	12	2	5	9		
(B-22.30)	(300)	(50)	(125)	(225)		
B-5.18	18	2	5	9		
(B-22.45)	(450)	(50)	(125)	(225)		
B-5.24	24	2	5	9		
(B-22.60)	(600)	(50)	(125)	(225)		

* For corner islands only.

Illinois Department of Transportation
 PASSED JONUCKY, L. 2015
 ENGINEER OF POLICY AND PROCEDURES
 APPROVED JONUCKY, L. 2015
 ENGINEER OF DESIGN AND ENVIRONMENT

GENERAL NOTES
 The bottom slope of combination curb and gutter constructed adjacent to pcc pavement shall be the same slope as the subbase or 6% when subbase is omitted.
 † = Thickness of pavement.
 Longitudinal joint tie bars shall be No. 6 (No. 19) at 24 (600) centers in accordance with details for longitudinal construction joint shown on Standard 420001.
 A minimum clearance of 2 (50) between the end of the tie bar and the back of the curb shall be maintained.
 The dowel bars shown in contraction joints will only be required for monolithic construction. See Standard 606301 for details of corner islands.
 All dimensions are in inches (millimeters) unless otherwise shown.

CONCRETE CURB TYPE B AND COMBINATION CONCRETE CURB AND GUTTER
 (Sheet 1 of 2)
STANDARD 606001-06

REVISIONS

DATE	REVISIONS
1-1-15	Added B-6.06 (B-15.15) barrier curb and gutter to table (corner islands only).
1-1-13	Added general note regarding requirement for dowel bars.

M-2.06 (M-5.15) and M-2.12 (M-5.30)

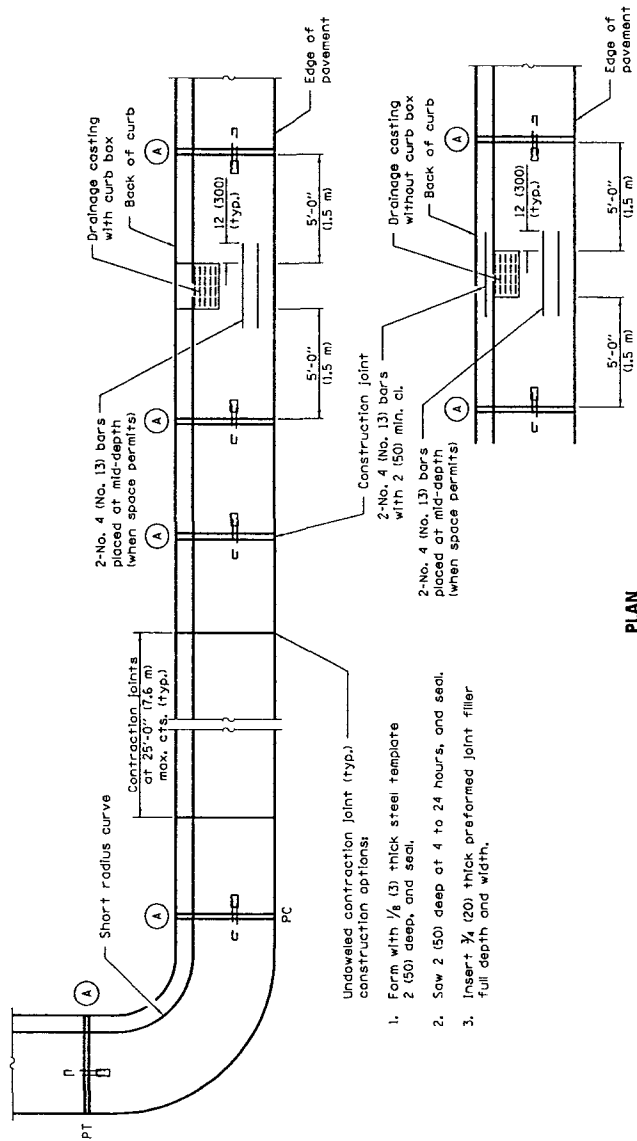

PLAN

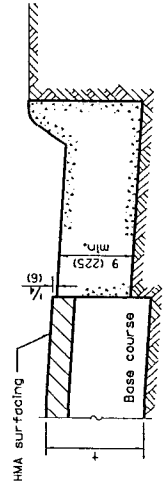

ON UNDISTURBED SUBGRADE

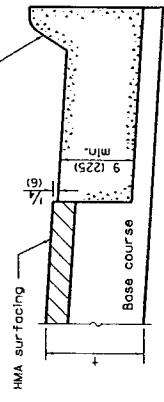

ON DISTURBED SUBGRADE

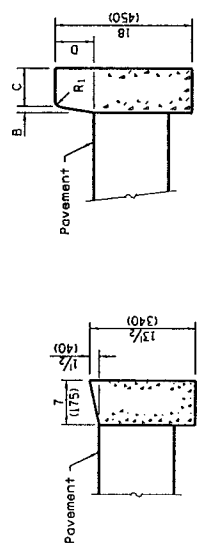

DEPRESSED CURB

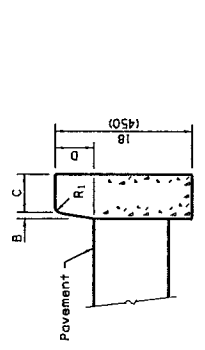

BARRIER CURB

ADJACENT TO FLEXIBLE PAVEMENT

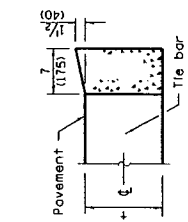

DEPRESSED CURB

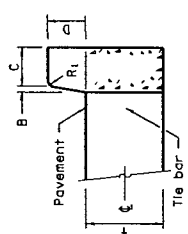

BARRIER CURB

ADJACENT TO PCC PAVEMENT OR PCC BASE COURSE

CONCRETE CURB TYPE B

**CONCRETE CURB TYPE B
AND COMBINATION
CONCRETE CURB AND GUTTER**
(Sheet 2 of 2)

STANDARD 606001-06

Illinois Department of Transportation
 PASSED January 1, 2015
 ENGINEER OF POLICY AND PROCEDURES
 APPROVED January 1, 2015
 ENGINEER OF DESIGN AND ENVIRONMENT

ISSUED 1-1-97

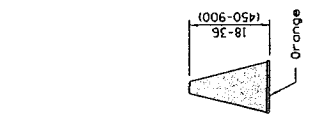

CONE

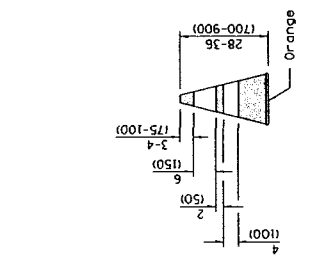

REFLECTORIZED CONE

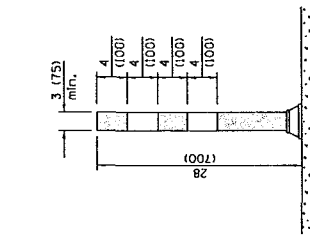

FLEXIBLE DELINEATOR

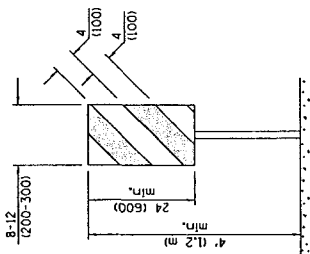

VERTICAL PANEL POST MOUNTED

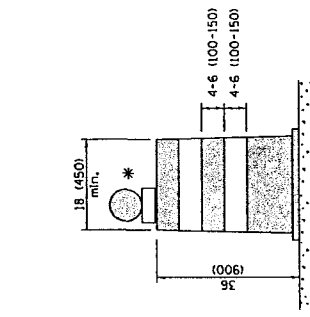

DRUM

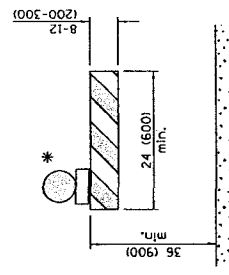

TYPE I BARRICADE

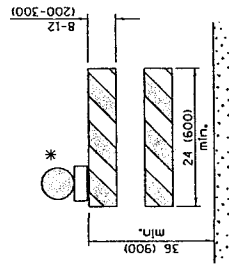

TYPE II BARRICADE

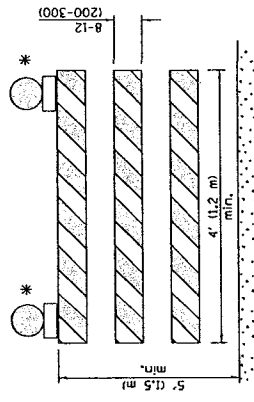

TYPE III BARRICADE

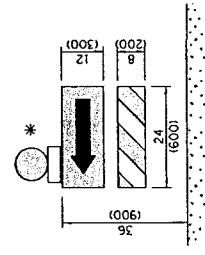

DIRECTION INDICATOR BARRICADE

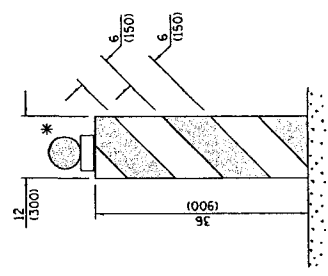

VERTICAL BARRICADE

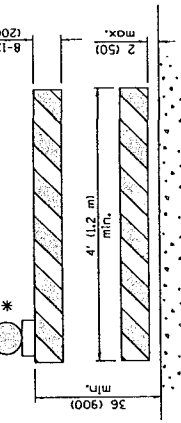

DETECTABLE PEDESTRIAN CHANNELIZING BARRICADE

* Warning lights (if required)

GENERAL NOTES
 All heights shown shall be measured above the pavement surface.
 All dimensions are in inches (millimeters) unless otherwise shown.

DATE	REVISIONS
1-1-15	Revised two sign numbers on sheet 2. Added note reg. PHOTO ENFORCED plaque.
1-1-14	Modified fogger sign height. Added highway construction speed zone signs.

TRAFFIC CONTROL DEVICES

STANDARD 701901-04 (Sheet 1 of 3)

Illinois Department of Transportation
 APPROVED [Signature] January 1, 2015
 ENGINEER OF OPERATIONS
 APPROVED [Signature] January 1, 2015
 ENGINEER OF DESIGN AND ENVIRONMENT

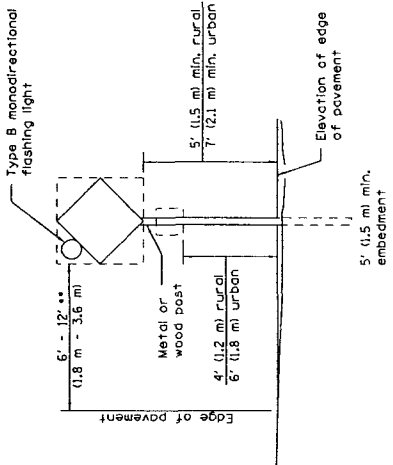

POST MOUNTED SIGNS

** When curb or paved shoulder are present this dimension shall be 24 (600) to the face of curb or 6' (1.8 m) to the outside edge of the paved shoulder.

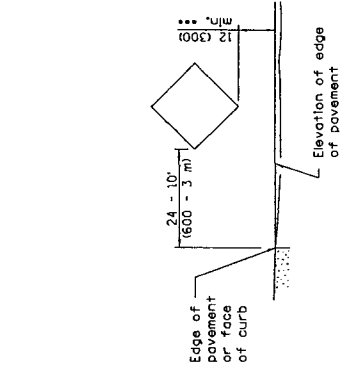

SIGNS ON TEMPORARY SUPPORTS

*** When work operations exceed four days, this dimension shall be 5' (1.5 m) min. If located behind other devices, the height shall be sufficient to be seen completely above the devices.

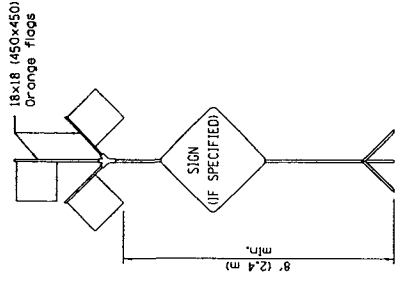

HIGH LEVEL WARNING DEVICE

ROAD CONSTRUCTION NEXT X MILES
G20-1104(O)-6036

END CONSTRUCTION
G20-1105(O)-6024

This signing is required for all projects 2 miles (3200 m) or more in length.
ROAD CONSTRUCTION NEXT X MILES sign shall be placed 500' (150 m) in advance of project limits.
END CONSTRUCTION sign shall be erected at the end of the job unless another job is within 2 miles (3200 m).
Dual sign displays shall be utilized on multi-lane highways.

WORK LIMIT SIGNING

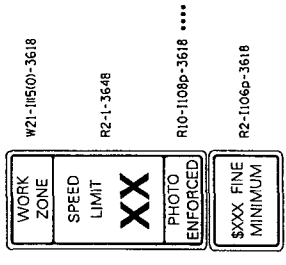

Sign assembly as shown on Standards or as allowed by District Operations.

END WORK ZONE SPEED LIMIT
G20-1103(O)-6036

This sign shall be used when the above sign assembly is used.

HIGHWAY CONSTRUCTION SPEED ZONE SIGNS

.... R10-1108p shall only be used along roadways under the jurisdiction of the State.

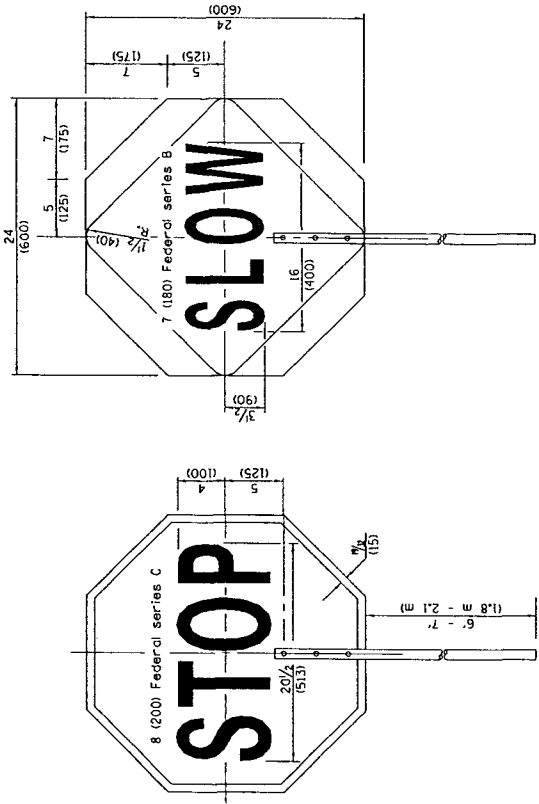

REVERSE SIDE

FRONT SIDE

TRAFFIC CONTROL DEVICES
(Sheet 2 of 3)

STANDARD 701901-04

FLAGGER TRAFFIC CONTROL SIGN

Illinois Department of Transportation

ISSUED 1-1-97

APPROVED 2005
ENGINEER OF OPERATIONS

APPROVED 2015
ENGINEER OF DESIGN AND ENVIRONMENT

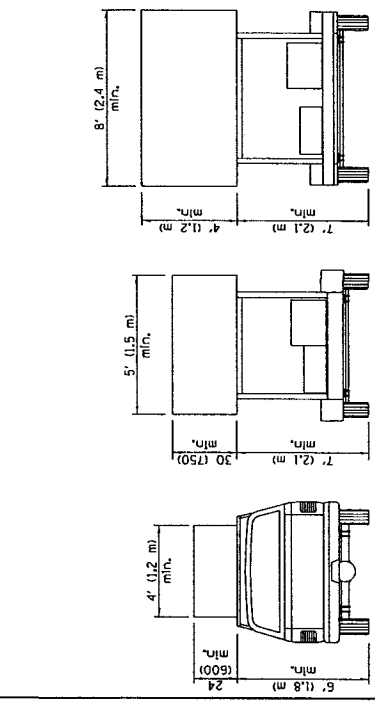
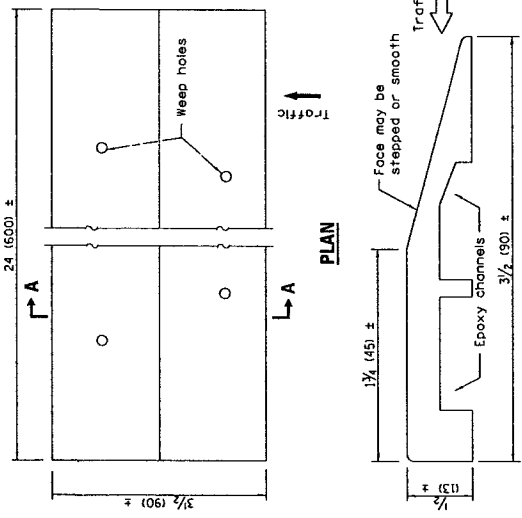
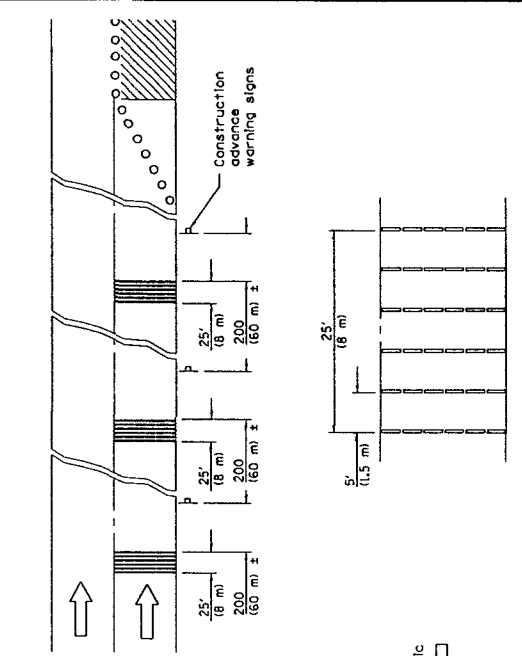

TYPE A
ROOF MOUNTED

TYPE B
ROOF OR TRAILER MOUNTED

TYPE C
TRAILER MOUNTED

ARROW BOARDS

TYPICAL INSTALLATION

TEMPORARY RUMBLE STRIPS

SECTION A-A

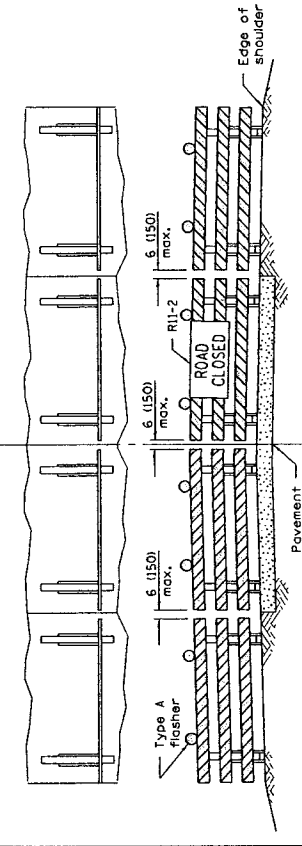

Refractorized striping may be omitted on the back side of the barricades if a Type III barricade with an attached sign panel which meets NCHRP 350 is not available, the sign may be mounted on an NCHRP 350 temporary sign support directly in front of the barricade.

ROAD CLOSED TO THRU TRAFFIC

Refractorized striping shall appear on both sides of the barricades. If a Type III barricade with an attached sign panel which meets NCHRP 350 is not available, the signs may be mounted on NCHRP 350 temporary sign supports directly in front of the barricade.

TYPICAL APPLICATIONS OF TYPE III BARRICADES CLOSING A ROAD

TRAFFIC CONTROL DEVICES

(Sheet 3 of 3)

STANDARD 701901-04

Illinois Department of Transportation

APPROVED: [Signature] NOVEMBER 11, 2015

ENGINEER OF OPERATIONS

APPROVED: [Signature] NOVEMBER 11, 2015

ENGINEER OF DESIGN AND ENVIRONMENT

ISSUED 1-1-97

Will County Prevailing Wage for July 2015

(See explanation of column headings at bottom of wages)

Trade Name	RG	TYP	C	Base	FRMAN	M-F>8	OSA	OSH	H/W	Pensn	Vac	Trng	
=====	==	===	=	=====	=====	=====	===	===	=====	=====	=====	=====	
ASBESTOS ABT-GEN	ALL			39.400	39.950	1.5	1.5	2.0	13.98	10.72	0.000	0.500	
ASBESTOS ABT-MEC	BLD			36.340	38.840	1.5	1.5	2.0	11.47	10.96	0.000	0.720	
BOILERMAKER	BLD			47.070	51.300	2.0	2.0	2.0	6.970	18.13	0.000	0.400	
BRICK MASON	BLD			43.780	48.160	1.5	1.5	2.0	10.05	14.43	0.000	1.030	
CARPENTER	ALL			44.350	48.790	2.0	2.0	2.0	11.99	18.47	0.000	0.630	
CEMENT MASON	ALL			41.000	43.000	2.0	1.5	2.0	10.00	20.39	0.000	0.500	
CERAMIC TILE FNSHER	BLD			36.810	0.000	1.5	1.5	2.0	10.55	9.230	0.000	0.770	
COMMUNICATION TECH	BLD			33.000	34.500	1.5	1.5	2.0	13.92	11.69	1.410	0.720	
ELECTRIC PWR EQMT OP	ALL			46.100	51.100	1.5	1.5	2.0	10.76	14.87	0.000	0.460	
ELECTRIC PWR GRNDMAN	ALL			37.050	52.500	1.5	2.0	2.0	8.630	12.28	0.000	0.370	
ELECTRIC PWR LINEMAN	ALL			47.500	52.500	1.5	2.0	1.5	10.76	14.87	0.000	0.460	
ELECTRICIAN	BLD			40.000	43.600	1.5	1.5	2.0	14.77	16.39	0.000	1.200	
ELEVATOR CONSTRUCTOR	BLD			50.800	57.150	2.0	2.0	2.0	13.57	14.21	4.060	0.600	
GLAZIER	BLD			40.500	42.000	1.5	2.0	2.0	13.14	16.99	0.000	0.940	
HT/FROST INSULATOR	BLD			48.450	50.950	1.5	1.5	2.0	11.47	12.16	0.000	0.720	
IRON WORKER	ALL			41.000	42.000	2.0	2.0	2.0	10.04	21.41	0.000	0.780	
LABORER	ALL			39.200	39.950	1.5	1.5	2.0	13.98	10.72	0.000	0.500	
LATHER	ALL			43.350	47.690	2.0	2.0	2.0	11.85	17.47	0.000	0.630	
MACHINIST	BLD			45.350	47.850	1.5	1.5	2.0	7.260	8.950	1.850	0.000	
MARBLE FINISHERS	ALL			32.400	34.320	1.5	1.5	2.0	10.05	13.75	0.000	0.620	
MARBLE MASON	BLD			43.030	47.330	1.5	1.5	2.0	10.05	14.10	0.000	0.780	
MATERIAL TESTER I	ALL			29.200	0.000	1.5	1.5	2.0	13.98	10.72	0.000	0.500	
MATERIALS TESTER II	ALL			34.200	0.000	1.5	1.5	2.0	13.98	10.72	0.000	0.500	
MILLWRIGHT	ALL			44.350	48.790	2.0	2.0	2.0	11.99	18.47	0.000	0.630	
OPERATING ENGINEER	BLD 1			48.100	52.100	2.0	2.0	2.0	17.55	12.65	1.900	1.250	
OPERATING ENGINEER	BLD 2			46.800	52.100	2.0	2.0	2.0	17.55	12.65	1.900	1.250	
OPERATING ENGINEER	BLD 3			44.250	52.100	2.0	2.0	2.0	17.55	12.65	1.900	1.250	
OPERATING ENGINEER	BLD 4			42.500	52.100	2.0	2.0	2.0	17.55	12.65	1.900	1.250	
OPERATING ENGINEER	BLD 5			51.850	52.100	2.0	2.0	2.0	17.55	12.65	1.900	1.250	
OPERATING ENGINEER	BLD 6			49.100	52.100	2.0	2.0	2.0	17.55	12.65	1.900	1.250	
OPERATING ENGINEER	BLD 7			51.100	52.100	2.0	2.0	2.0	17.55	12.65	1.900	1.250	
OPERATING ENGINEER	FLT 1			53.600	53.600	1.5	1.5	2.0	17.10	11.80	1.900	1.250	
OPERATING ENGINEER	FLT 2			52.100	53.600	1.5	1.5	2.0	17.10	11.80	1.900	1.250	
OPERATING ENGINEER	FLT 3			46.400	53.600	1.5	1.5	2.0	17.10	11.80	1.900	1.250	
OPERATING ENGINEER	FLT 4			38.550	53.600	1.5	1.5	2.0	17.10	11.80	1.900	1.250	
OPERATING ENGINEER	FLT 5			55.100	53.600	1.5	1.5	2.0	17.10	11.80	1.900	1.250	
OPERATING ENGINEER	FLT 6			35.000	35.000	1.5	1.5	2.0	16.60	11.05	1.900	1.250	
OPERATING ENGINEER	HWY 1			46.300	50.300	1.5	1.5	2.0	17.55	12.65	1.900	1.250	
OPERATING ENGINEER	HWY 2			45.750	50.300	1.5	1.5	2.0	17.55	12.65	1.900	1.250	
OPERATING ENGINEER	HWY 3			43.700	50.300	1.5	1.5	2.0	17.55	12.65	1.900	1.250	
OPERATING ENGINEER	HWY 4			42.300	50.300	1.5	1.5	2.0	17.55	12.65	1.900	1.250	
OPERATING ENGINEER	HWY 5			41.100	50.300	1.5	1.5	2.0	17.55	12.65	1.900	1.250	
OPERATING ENGINEER	HWY 6			49.300	50.300	1.5	1.5	2.0	17.55	12.65	1.900	1.250	
OPERATING ENGINEER	HWY 7			47.300	50.300	1.5	1.5	2.0	17.55	12.65	1.900	1.250	
PAINTER	ALL			41.750	46.500	1.5	1.5	1.5	11.50	11.10	0.000	0.770	
PAINTER SIGNS	BLD			33.920	38.090	1.5	1.5	1.5	2.600	2.710	0.000	0.000	
PILEDRIVER	ALL			44.350	48.790	2.0	2.0	2.0	11.99	18.47	0.000	0.630	
PIPEFITTER	BLD			46.000	49.000	1.5	1.5	2.0	9.000	15.85	0.000	1.780	
PLASTERER	BLD			43.430	46.040	1.5	1.5	2.0	13.05	14.43	0.000	1.020	
PLUMBER	BLD			46.650	48.650	1.5	1.5	2.0	13.18	11.46	0.000	0.880	
ROOFER	BLD			41.000	44.000	1.5	1.5	2.0	8.280	10.54	0.000	0.530	
SHEETMETAL WORKER	BLD			44.720	46.720	1.5	1.5	2.0	10.65	13.31	0.000	0.820	
SPRINKLER FITTER	BLD			49.200	51.200	1.5	1.5	2.0	11.75	9.650	0.000	0.550	
STONE MASON	BLD			43.780	48.160	1.5	1.5	2.0	10.05	14.43	0.000	1.030	
SURVEY WORKER	----->NOT IN EFFECT			ALL	37.000	37.750	1.5	1.5	2.0	12.97	9.930	0.000	0.500

TERRAZZO FINISHER	BLD	38.040	0.000	1.5	1.5	2.0	10.55	11.22	0.000	0.720
TERRAZZO MASON	BLD	41.880	44.880	1.5	1.5	2.0	10.55	12.51	0.000	0.940
TILE MASON	BLD	43.840	47.840	1.5	1.5	2.0	10.55	11.40	0.000	0.990
TRAFFIC SAFETY WRKR	HWY	32.750	34.350	1.5	1.5	2.0	6.550	6.450	0.000	0.500
TRUCK DRIVER	ALL 1	35.650	36.200	1.5	1.5	2.0	7.250	6.319	0.000	0.250
TRUCK DRIVER	ALL 2	35.800	36.200	1.5	1.5	2.0	7.250	6.319	0.000	0.250
TRUCK DRIVER	ALL 3	36.000	36.200	1.5	1.5	2.0	7.250	6.319	0.000	0.250
TRUCK DRIVER	ALL 4	36.200	36.200	1.5	1.5	2.0	7.250	6.319	0.000	0.250
TUCKPOINTER	BLD	43.800	44.800	1.5	1.5	2.0	8.280	13.49	0.000	0.670

Legend: RG (Region)

TYP (Trade Type - All,Highway,Building,Floating,Oil & Chip,Rivers)

C (Class)

Base (Base Wage Rate)

FRMAN (Foreman Rate)

M-F>8 (OT required for any hour greater than 8 worked each day, Mon through Fri.)

OSA (Overtime (OT) is required for every hour worked on Saturday)

OSH (Overtime is required for every hour worked on Sunday and Holidays)

H/W (Health & Welfare Insurance)

Pensn (Pension)

Vac (Vacation)

Trng (Training)

Explanations

WILL COUNTY

The following list is considered as those days for which holiday rates of wages for work performed apply: New Years Day, Memorial Day, Fourth of July, Labor Day, Thanksgiving Day, Christmas Day and Veterans Day in some classifications/counties. Generally, any of these holidays which fall on a Sunday is celebrated on the following Monday. This then makes work performed on that Monday payable at the appropriate overtime rate for holiday pay. Common practice in a given local may alter certain days of celebration. If in doubt, please check with IDOL.

EXPLANATION OF CLASSES

ASBESTOS - GENERAL - removal of asbestos material/mold and hazardous materials from any place in a building, including mechanical systems where those mechanical systems are to be removed. This includes the removal of asbestos materials/mold and hazardous materials from ductwork or pipes in a building when the building is to be demolished at the time or at some close future date.

ASBESTOS - MECHANICAL - removal of asbestos material from mechanical systems, such as pipes, ducts, and boilers, where the mechanical systems are to remain.

CERAMIC TILE FINISHER

The grouting, cleaning, and polishing of all classes of tile, whether for interior or exterior purposes, all burned, glazed or unglazed products; all composition materials, granite tiles, warning detectable tiles, cement tiles, epoxy composite materials, pavers, glass, mosaics, fiberglass, and all substitute materials, for tile made in tile-like units; all mixtures in tile like form of cement, metals, and other materials that are for and intended for use as a finished floor surface, stair treads, promenade roofs, walks, walls, ceilings, swimming pools, and all other places where tile is to form a finished interior or exterior. The mixing of all setting mortars including but not limited to thin-set mortars, epoxies, wall mud, and any other

sand and cement mixtures or adhesives when used in the preparation, installation, repair, or maintenance of tile and/or similar materials. The handling and unloading of all sand, cement, lime, tile, fixtures, equipment, adhesives, or any other materials to be used in the preparation, installation, repair, or maintenance of tile and/or similar materials. Ceramic Tile Finishers shall fill all joints and voids regardless of method on all tile work, particularly and especially after installation of said tile work. Application of any and all protective coverings to all types of tile installations including, but not be limited to, all soap compounds, paper products, tapes, and all polyethylene coverings, plywood, masonite, cardboard, and any new type of products that may be used to protect tile installations, Blastrac equipment, and all floor scarifying equipment used in preparing floors to receive tile. The clean up and removal of all waste and materials. All demolition of existing tile floors and walls to be re-tiled.

COMMUNICATIONS TECHNICIAN

Installation, operation, inspection, maintenance, repair and service of radio, television, recording, voice, sound and vision production and reproduction, telephone and telephone interconnect, facsimile, equipment and appliances used for domestic, commercial, educational and entertainment purposes, pulling of wire through conduit but not the installation of conduit.

MARBLE FINISHER

Loading and unloading trucks, distribution of all materials (all stone, sand, etc.), stocking of floors with material, performing all rigging for heavy work, the handling of all material that may be needed for the installation of such materials, building of scaffolding, polishing if needed, patching, waxing of material if damaged, pointing up, caulking, grouting and cleaning of marble, holding water on diamond or Carborundum blade or saw for setters cutting, use of tub saw or any other saw needed for preparation of material, drilling of holes for wires that anchor material set by setters, mixing up of molding plaster for installation of material, mixing up thin set for the installation of material, mixing up of sand to cement for the installation of material and such other work as may be required in helping a Marble Setter in the handling of all material in the erection or installation of interior marble, slate, travertine, art marble, serpentine, alberene stone, blue stone, granite and other stones (meaning as to stone any foreign or domestic materials as are specified and used in building interiors and exteriors and customarily known as stone in the trade), carrara, sanionyx, vitrolite and similar opaque glass and the laying of all marble tile, terrazzo tile, slate tile and precast tile, steps, risers treads, base, or any other materials that may be used as substitutes for any of the aforementioned materials and which are used on interior and exterior which are installed in a similar manner.

MATERIAL TESTER I: Hand coring and drilling for testing of materials; field inspection of uncured concrete and asphalt.

MATERIAL TESTER II: Field inspection of welds, structural steel, fireproofing, masonry, soil, facade, reinforcing steel, formwork, cured concrete, and concrete and asphalt batch plants; adjusting proportions of bituminous mixtures.

OPERATING ENGINEER - BUILDING

Class 1. Asphalt Plant; Asphalt Spreader; Autograde; Backhoes with Caisson Attachment; Batch Plant; Benoto (requires Two Engineers);

Boiler and Throttle Valve; Caisson Rigs; Central Redi-Mix Plant; Combination Back Hoe Front End-loader Machine; Compressor and Throttle Valve; Concrete Breaker (Truck Mounted); Concrete Conveyor; Concrete Conveyor (Truck Mounted); Concrete Paver Over 27E cu. ft.; Concrete Paver 27E cu. ft. and Under; Concrete Placer; Concrete Placing Boom; Concrete Pump (Truck Mounted); Concrete Tower; Cranes, All; Cranes, Hammerhead; Cranes, (GCI and similar Type); Creter Crane; Spider Crane; Crusher, Stone, etc.; Derricks, All; Derricks, Traveling; Formless Curb and Gutter Machine; Grader, Elevating; Grouting Machines; Heavy Duty Self-Propelled Transporter or Prime Mover; Highlift Shovels or Front Endloader 2-1/4 yd. and over; Hoists, Elevators, outside type rack and pinion and similar machines; Hoists, One, Two and Three Drum; Hoists, Two Tugger One Floor; Hydraulic Backhoes; Hydraulic Boom Trucks; Hydro Vac (and similar equipment); Locomotives, All; Motor Patrol; Lubrication Technician; Manipulators; Pile Drivers and Skid Rig; Post Hole Digger; Pre-Stress Machine; Pump Cretes Dual Ram; Pump Cretes: Squeeze Cretes-Screw Type Pumps; Gypsum Bulker and Pump; Raised and Blind Hole Drill; Roto Mill Grinder; Scoops - Tractor Drawn; Slip-Form Paver; Straddle Buggies; Operation of Tie Back Machine; Tournapull; Tractor with Boom and Side Boom; Trenching Machines.

Class 2. Boilers; Broom, All Power Propelled; Bulldozers; Concrete Mixer (Two Bag and Over); Conveyor, Portable; Forklift Trucks; Highlift Shovels or Front Endloaders under 2-1/4 yd.; Hoists, Automatic; Hoists, Inside Elevators; Hoists, Sewer Dragging Machine; Hoists, Tugger Single Drum; Laser Screed; Rock Drill (Self-Propelled); Rock Drill (Truck Mounted); Rollers, All; Steam Generators; Tractors, All; Tractor Drawn Vibratory Roller; Winch Trucks with "A" Frame.

Class 3. Air Compressor; Combination Small Equipment Operator; Generators; Heaters, Mechanical; Hoists, Inside Elevators (remodeling or renovation work); Hydraulic Power Units (Pile Driving, Extracting, and Drilling); Pumps, over 3" (1 to 3 not to exceed a total of 300 ft.); Low Boys; Pumps, Well Points; Welding Machines (2 through 5); Winches, 4 Small Electric Drill Winches.

Class 4. Bobcats and/or other Skid Steer Loaders; Oilers; and Brick Forklift.

Class 5. Assistant Craft Foreman.

Class 6. Gradall.

Class 7. Mechanics; Welders.

OPERATING ENGINEERS - HIGHWAY CONSTRUCTION

Class 1. Asphalt Plant; Asphalt Heater and Planer Combination; Asphalt Heater Scarfire; Asphalt Spreader; Autograder/GOMACO or other similar type machines: ABG Paver; Backhoes with Caisson Attachment; Ballast Regulator; Belt Loader; Caisson Rigs; Car Dumper; Central Redi-Mix Plant; Combination Backhoe Front Endloader Machine, (1 cu. yd. Backhoe Bucket or over or with attachments); Concrete Breaker (Truck Mounted); Concrete Conveyor; Concrete Paver over 27E cu. ft.; Concrete Placer; Concrete Tube Float; Cranes, all attachments; Cranes, Tower Cranes of all types: Creter Crane: Spider Crane; Crusher, Stone, etc.; Derricks, All; Derrick Boats; Derricks, Traveling; Dredges; Elevators, Outside type Rack & Pinion and Similar Machines; Formless Curb and Gutter Machine; Grader, Elevating; Grader, Motor Grader, Motor Patrol, Auto Patrol, Form Grader, Pull Grader, Subgrader; Guard Rail Post Driver Truck Mounted; Hoists, One, Two, and Three Drum; Heavy Duty Self-Propelled Transporter or Prime Mover; Hydraulic Backhoes;

Backhoes with shear attachments up to 40' of boom reach; Lubrication Technician; Manipulators; Mucking Machine; Pile Drivers and Skid Rig; Pre-Stress Machine; Pump Cretes Dual Ram; Rock Drill - Crawler or Skid Rig; Rock Drill - Truck Mounted; Rock/Track Tamper; Roto Mill Grinder; Slip-Form Paver; Snow Melters; Soil Test Drill Rig (Truck Mounted); Straddle Buggies; Hydraulic Telescoping Form (Tunnel); Operation of Tieback Machine; Tractor Drawn Belt Loader; Tractor Drawn Belt Loader (with attached pusher - two engineers); Tractor with Boom; Tractaire with Attachments; Traffic Barrier Transfer Machine; Trenching; Truck Mounted Concrete Pump with Boom; Raised or Blind Hole Drills (Tunnel Shaft); Underground Boring and/or Mining Machines 5 ft. in diameter and over tunnel, etc; Underground Boring and/or Mining Machines under 5 ft. in diameter; Wheel Excavator; Widener (APSCO).

Class 2. Batch Plant; Bituminous Mixer; Boiler and Throttle Valve; Bulldozers; Car Loader Trailing Conveyors; Combination Backhoe Front Endloader Machine (Less than 1 cu. yd. Backhoe Bucket or over or with attachments); Compressor and Throttle Valve; Compressor, Common Receiver (3); Concrete Breaker or Hydro Hammer; Concrete Grinding Machine; Concrete Mixer or Paver 7S Series to and including 27 cu. ft.; Concrete Spreader; Concrete Curing Machine, Burlap Machine, Belting Machine and Sealing Machine; Concrete Wheel Saw; Conveyor Muck Cars (Haglund or Similar Type); Drills, All; Finishing Machine - Concrete; Highlift Shovels or Front Endloader; Hoist - Sewer Dragging Machine; Hydraulic Boom Trucks (All Attachments); Hydro-Blaster; Hydro Excavating (excluding hose work); Laser Screed; All Locomotives, Dinky; Off-Road Hauling Units (including articulating) Non Self-Loading Ejection Dump; Pump Cretes: Squeeze Cretes - Screw Type Pumps, Gypsum Bulker and Pump; Roller, Asphalt; Rotary Snow Plows; Rototiller, Seaman, etc., self-propelled; Self-Propelled Compactor; Spreader - Chip - Stone, etc.; Scraper - Single/Twin Engine/Push and Pull; Scraper - Prime Mover in Tandem (Regardless of Size); Tractors pulling attachments, Sheeps Foot, Disc, Compactor, etc.; Tug Boats.

Class 3. Boilers; Brooms, All Power Propelled; Cement Supply Tender; Compressor, Common Receiver (2); Concrete Mixer (Two Bag and Over); Conveyor, Portable; Farm-Type Tractors Used for Mowing, Seeding, etc.; Forklift Trucks; Grouting Machine; Hoists, Automatic; Hoists, All Elevators; Hoists, Tugger Single Drum; Jeep Diggers; Low Boys; Pipe Jacking Machines; Post-Hole Digger; Power Saw, Concrete Power Driven; Pug Mills; Rollers, other than Asphalt; Seed and Straw Blower; Steam Generators; Stump Machine; Winch Trucks with "A" Frame; Work Boats; Tamper-Form-Motor Driven.

Class 4. Air Compressor; Combination - Small Equipment Operator; Directional Boring Machine; Generators; Heaters, Mechanical; Hydraulic Power Unit (Pile Driving, Extracting, or Drilling); Light Plants, All (1 through 5); Pumps, over 3" (1 to 3 not to exceed a total of 300 ft.); Pumps, Well Points; Vacuum Trucks (excluding hose work); Welding Machines (2 through 5); Winches, 4 Small Electric Drill Winches.

Class 5. SkidSteer Loader (all); Brick Forklifts; Oilers.

Class 6. Field Mechanics and Field Welders

Class 7. Dowell Machine with Air Compressor; Gradall and machines of like nature.

OPERATING ENGINEER - FLOATING

Class 1. Craft Foreman; Master Mechanic; Diver/Wet Tender; Engineer; Engineer (Hydraulic Dredge).

Class 2. Crane/Backhoe Operator; Boat Operator with towing

endorsement; Mechanic/Welder; Assistant Engineer (Hydraulic Dredge); Leverman (Hydraulic Dredge); Diver Tender.

Class 3. Deck Equipment Operator, Machineryman, Maintenance of Crane (over 50 ton capacity) or Backhoe (115,000 lbs. or more); Tug/Launch Operator; Loader/Dozer and like equipment on Barge, Breakwater Wall, Slip/Dock, or Scow, Deck Machinery, etc.

Class 4. Deck Equipment Operator, Machineryman/Fireman (4 Equipment Units or More); Off Road Trucks; Deck Hand, Tug Engineer, Crane Maintenance (50 Ton Capacity and Under) or Backhoe Weighing (115,000 pounds or less); Assistant Tug Operator.

Class 5. Friction or Lattice Boom Cranes.

Class 6. ROV Pilot, ROV Tender

SURVEY WORKER - Operated survey equipment including data collectors, G.P.S. and robotic instruments, as well as conventional levels and transits.

TRAFFIC SAFETY - work associated with barricades, horses and drums used to reduce lane usage on highway work, the installation and removal of temporary lane markings, and the installation and removal of temporary road signs.

TRUCK DRIVER - BUILDING, HEAVY AND HIGHWAY CONSTRUCTION

Class 1. Two or three Axle Trucks. A-frame Truck when used for transportation purposes; Air Compressors and Welding Machines, including those pulled by cars, pick-up trucks and tractors; Ambulances; Batch Gate Lockers; Batch Hopperman; Car and Truck Washers; Carry-alls; Fork Lifts and Hoisters; Helpers; Mechanics Helpers and Greasers; Oil Distributors 2-man operation; Pavement Breakers; Pole Trailer, up to 40 feet; Power Mower Tractors; Self-propelled Chip Spreader; Skipman; Slurry Trucks, 2-man operation; Slurry Truck Conveyor Operation, 2 or 3 man; Teamsters; Unskilled Dumpman; and Truck Drivers hauling warning lights, barricades, and portable toilets on the job site.

Class 2. Four axle trucks; Dump Crets and Adgetors under 7 yards; Dumpsters, Track Trucks, Euclids, Hug Bottom Dump Turnapulls or Turnatrailers when pulling other than self-loading equipment or similar equipment under 16 cubic yards; Mixer Trucks under 7 yards; Ready-mix Plant Hopper Operator, and Winch Trucks, 2 Axles.

Class 3. Five axle trucks; Dump Crets and Adgetors 7 yards and over; Dumpsters, Track Trucks, Euclids, Hug Bottom Dump Turnatrailers or turnapulls when pulling other than self-loading equipment or similar equipment over 16 cubic yards; Explosives and/or Fission Material Trucks; Mixer Trucks 7 yards or over; Mobile Cranes while in transit; Oil Distributors, 1-man operation; Pole Trailer, over 40 feet; Pole and Expandable Trailers hauling material over 50 feet long; Slurry trucks, 1-man operation; Winch trucks, 3 axles or more; Mechanic--Truck Welder and Truck Painter.

Class 4. Six axle trucks; Dual-purpose vehicles, such as mounted crane trucks with hoist and accessories; Foreman; Master Mechanic; Self-loading equipment like P.B. and trucks with scoops on the front.

TERRAZZO FINISHER

The handling of sand, cement, marble chips, and all other materials that may be used by the Mosaic Terrazzo Mechanic, and the mixing,

grinding, grouting, cleaning and sealing of all Marble, Mosaic, and Terrazzo work, floors, base, stairs, and wainscoting by hand or machine, and in addition, assisting and aiding Marble, Masonic, and Terrazzo Mechanics.

Other Classifications of Work:

For definitions of classifications not otherwise set out, the Department generally has on file such definitions which are available. If a task to be performed is not subject to one of the classifications of pay set out, the Department will upon being contacted state which neighboring county has such a classification and provide such rate, such rate being deemed to exist by reference in this document. If no neighboring county rate applies to the task, the Department shall undertake a special determination, such special determination being then deemed to have existed under this determination. If a project requires these, or any classification not listed, please contact IDOL at 217-782-1710 for wage rates or clarifications.

LANDSCAPING

Landscaping work falls under the existing classifications for laborer, operating engineer and truck driver. The work performed by landscape plantsman and landscape laborer is covered by the existing classification of laborer. The work performed by landscape operators (regardless of equipment used or its size) is covered by the classifications of operating engineer. The work performed by landscape truck drivers (regardless of size of truck driven) is covered by the classifications of truck driver.

MATERIAL TESTER & MATERIAL TESTER/INSPECTOR I AND II

Notwithstanding the difference in the classification title, the classification entitled "Material Tester I" involves the same job duties as the classification entitled "Material Tester/Inspector I". Likewise, the classification entitled "Material Tester II" involves the same job duties as the classification entitled "Material Tester/Inspector II".

**DEPARTMENT OF
PUBLIC WORKS**

815-724-4200 Direct
815-723-7770 Fax



CITY OF JOLIET

GENERAL CONTRACTOR

**150 WEST JEFFERSON STREET
JOLIET, ILLINOIS 60432-4158**

RE: 2016 CONSTRUCTION PROJECTS

Dear General Contractor:

The City of Joliet currently has specifications, which require ten (**10%**) percent minority participation in contracts over \$100,000.00. In an effort to track this information letter, the City of Joliet will be requiring all GENERAL CONTRACTS to submit to a complete list of sub-contractors they intend to use on the awarded project at the pre-construction meeting. The issuance of this sub-contractor list will help the City ensure that minority requirements are met as well as prevailing wages. The sub-contractor list should include the dollar amount or percentage of this contract for the work the sub-contractor is responsible. I.D.O.T. for BC 260-A is an example of such an acceptable form. In addition, the specification states that monthly certified payroll records are to be submitted to the Engineer. This will also be enforced for the upcoming construction season.

The City of Joliet appreciates your effort throughout the years and looks forward to working with you in the upcoming construction season.

James R. Trizna
Public Works Director

James E. Eggen
Public Utilities Director

NOTICE TO BIDDERS - ETHICS ORDINANCE

The City of Joliet has approved an Ethics Ordinance on August 18, 1992 (Ordinance No. 9967; Section 2-333 et seq. of the Code of Ordinances of the City of Joliet). The Ethics Ordinance prohibits any City of Joliet elected or appointed official or any City of Joliet employee from receiving or soliciting anything of value to influence that City official or employee in carrying out his or her official duties. The City of Joliet appreciates your anticipated cooperation in refraining from offering any official or employee anything, item, service, or favor of value to influence that person's decision on any City business. With your cooperation, the City of Joliet will achieve its goal of maintaining a fair and competitive contract procedure that promotes the best interests of the citizens of the City of Joliet. You should report immediately any violation of the Ethics Ordinance to the City Manager, including any solicitation of a thing of value by a City official or employee. A bidder or contractor's participation or encouragement in the violation of the Ethics Ordinance may result in the rejection of a bid, termination of contract, or declaration of ineligibility to bid on future contracts. A copy of the Ethics Ordinance is available in the City Clerk's office for your review.

CITY OF JOLIET
STATE OF ILLINOIS

PROPOSAL FORM

NOTE: ALL BLANKS ON EACH AND EVERY SHEET OF THIS PROPOSAL SHALL BE COMPLETED. FAILURE TO COMPLETE ALL BLANKS SHALL BE GROUNDS FOR REJECTION OF BIDS.

TO THE MAYOR AND CITY COUNCIL OF JOLIET, ILLINOIS:

1. PROPOSAL OF _____
(Name and Address of Bidder)

2. The plans for the proposed work are those prepared by the City Engineer and approved by the City Council of the City of Joliet, Illinois on _____.

The specifications herein referred to are those prepared by the City Engineer.
3. In submitting this proposal, the undersigned declares that the only persons or parties interested in the proposal as principals are those named herein; and that the proposal is made without collusion with any other person, firm, or corporation.
4. The undersigned further declares that he has carefully examined the proposal, plans, specifications, form of contract and contract bond, and special provisions, and that he has inspected in detail the site of the proposed work, and that he has familiarized himself with all of the local conditions affecting the contract and the detailed requirements of construction, and he understands that in making this proposal he waives all right to plead any misunderstanding regarding the same.
5. The undersigned further understands and agrees that if this proposal is accepted he is to furnish and provide all necessary machinery, tools, apparatus, and other means of construction, in the respective sections, and to do all of the work, and to furnish all of the materials specified in the contract.
6. The undersigned declares that he understands that the quantities mentioned are approximate only and that they are subject to increase or decrease; that he will take in full payment therefore the amount and the summation of the actual quantities, as finally determined multiplied by the unit price shown in the schedule of prices contained herein.
7. The undersigned further agrees that the unit prices submitted herewith are for the purpose of obtaining a gross sum, and for use in computing the value of extras and deduction; that if there is a discrepancy between the gross sum bid and that resulting from the summation of the quantities multiplied by their respective unit prices, the latter shall apply.
8. The undersigned further agrees that if the owner decides to extend or shorten improvement, or otherwise alter it by extras or deductions, including the

elimination of any one or more of the items, by an amount not to exceed twenty-five (25) percent of the total money value of the original contract price or contract price corrected as provided in the specifications, he will perform the work as altered, increased or decreased at the contract unit price.

9. The undersigned further agrees that the Engineer may at any time during the progress of the work covered by this contract, order other materials as do not appear in the proposal or contract as a specific item accompanied by a unit price, and which are not included under the bid price for other items in this contract, shall be performed as extra work, and that he will accept as full compensation therefore the actual cost plus fifteen percent (15%), the actual cost to be determined as provided in the specification.
10. The undersigned further agrees to execute a contract for this work and present the same to the City of Joliet within fifteen (15) days after the date of the notice of the award of the contract to him.
11. The undersigned further agrees that he and his surety will execute and present within fifteen (15) days after the date of the notice of the award of the contract, a contract bond satisfactory to and in the form prescribed by the City of Joliet in the penal sum of one hundred percent (100%) of the full amount of the contract within the terms of the contract.
12. The undersigned further agrees to begin work not later than ten (10) days after the execution of the acceptance of the contract and contract bond, unless otherwise provided and to prosecute the work in such manner and with sufficient materials, equipment, and labor as will insure its completion within the time limit specified herein, it being understood and agreed that the completion within the time limit is an essential part of the contract. The undersigned agrees to complete the work within **60 consecutive working days** after execution of the contract, by both parties, unless additional time shall be granted by the Engineer in accordance with provisions of the specifications.

In case of failure to complete the work in or before the time named herein or within such extra time as may have been allowed by extensions, the undersigned agrees that the City of Joliet shall withhold, from each sum as may be due him under the terms of this contract, the costs, set forth in the specifications of the contract, which costs shall be considered and treated not as a penalty but as damages due to the City of Joliet from the undersigned by reason of inconvenience to the public, added cost of engineering and supervision and other items which have caused an expenditure of public funds resulting from the failure of the undersigned to complete the work within the time specified in the contract.

13. Accompanying this proposal is a bank draft, bank cashier's check, bid bond or a certified check, complying with the requirements of the specifications, made payable to the City of Joliet.

THE AMOUNT OF THE CHECK OR DRAFT IS (\$ _____)

If this proposal is accepted and the undersigned shall fail to execute a contract and contract bond as required within, it is hereby agreed that the amount of the check or bank draft shall become the property of the City of Joliet and shall be considered as payment of damages due to delay and other causes suffered by the City of Joliet because of the failure to execute said contract and contract bond; otherwise said check or draft, shall be returned to the undersigned.

14. The undersigned submits herewith his schedule of prices covering the work to be performed under this contract; he understands that he must show in the schedule of unit prices for which he proposes each item of work, that the extensions must be made by him and that if not so done his proposal may be rejected as irregular.
15. All bidders must furnish current financial statement with the bid.
16. All bidders must furnish a list of equipment available for and to be use on this project with their bid.

17. The undersigned submits herewith his schedule of prices covering the work to be performed under this contract.

CITY OF JOLIET						
BETHEL/DOUGLASKUNGS/WALSH WATERMAIN IMPROVEMENT PROJECT - 2016						
SCHEDULE OF PRICES						
(FOR MORE INFORMATION REGARDING THESE ITEMS SEE PLANS AND SPECIFICATIONS)						
SEQUENCE	CODE	ITEM DESCRIPTION	QUANTITY	UNITS	UNIT PRICE	COST
1	10	TRENCH BACKFILL	6500	CU YD		
2	45	STORM SEWER REMOVAL & REPLACEMENT, 12"	100	LIN FT		
3	49	8" X 8" TAPPING SLEEVE & VALVE IN 4' DIA. VALVE VAULT	1	EACH		
4	50	DUCTILE IRON WATER MAIN 10", CLASS 52	1100	LIN FT		
5	50A	DUCTILE IRON WATER MAIN 8", CLASS 52	4700	LIN FT		
6	50B	DUCTILE IRON WATER MAIN 6", CLASS 52	250	LIN FT		
7	51	10" GATE VALVE COMPLETE WITH VALVE BOX	7	EACH		
8	51A	8" GATE VALVE COMPLETE WITH VALVE BOX	25	EACH		
9	51B	6" GATE VALVE IN 4' DIA. VALVE VAULT, TYPE A W/ FRAME & LID	1	EACH		
10	52	WATER SERVICE CONNECTION	90	EACH		
11	53	WATER SERVICE LINE, COPPER TYPE K - 1"	1500	LIN FT		
12	53A	WATER SERVICE LINE, COPPER TYPE K - 1.5"	100	LIN FT		
13	53B	WATER SERVICE LINE, COPPER TYPE K - 2"	1500	LIN FT		
14	54	MISCELLANEOUS FITTINGS	7500	POUND		
15	61	10" X 8" TEE (TYLER 5-635 OR EQUIVALENT)	2	EACH		
16	61A	10" X 6" TEE (TYLER 5-635 OR EQUIVALENT)	2	EACH		
17	61B	8" X 8" TEE (TYLER 5-635 OR EQUIVALENT)	1	EACH		
18	61C	8" X 6" TEE (TYLER 5-635 OR EQUIVALENT)	14	EACH		
19	122	COMBINATION CONCRETE CURB & GUTTER REMOVAL & REPLACEMENT	500	LIN FT		
20	124	SIDEWALK REMOVAL & REPLACEMENT	2500	SQ FT		
21	125	DRIVEWAY PAVEMENT REMOVAL & REPLACEMENT, 4"	250	SQ YD		
22	128	PORTLAND CEMENT CONCRETE DRIVEWAY PAVEMENT R&R, 8"	250	SQ YD		
23	128A	PORTLAND CEMENT CONCRETE DRIVEWAY PAVEMENT R&R, 6"	250	SQ YD		
24	134	FIRE HYDRANT COMPLETE WITH AUXILIARY VALVE	15	EACH		
25	140	FURNISHING AND PLACING TOPSOIL	1500	SQ YD		
26	141	SEEDING, TYPE A W/MULCH, METHOD A	1500	SQ YD		
27	145	TRAFFIC CONTROL AND PROTECTION	1	L SUM		
28	153	SAWCUT ASPHALT SURFACE	12500	LIN FT		
29	154	SAWCUT CONCRETE SURFACE	750	LIN FT		
30	159	HOT MIX ASPHALT REMOVAL & REPLACEMENT, 4"	4550	SQ YD		
31	X	CONNECT TO EXISTING 6" WATERMAIN W/ SLEEVE & FITTINGS	3	EACH		
32	X	DUCTILE IRON WATER MAIN 10", CLASS 52, BORED IN PLACE W/ SNAP-LOCK JOINTS	70	LIN FT		
33	X	6" M.J. PLUG	2	EACH		
34	X	10" X 6" REDUCER	2	EACH		
35	X	8" X 6" REDUCER	1	EACH		
36	X	VALVE BOX TO BE REMOVED	1	EACH		
37	X	VALVE VAULT TO BE REMOVED	14	EACH		
38	X	SANITARY SEWER SERVICE R&R, SDR 35, 6"	150	LIN FT		
39	X	STRIPING	1	L SUM		
40	X	REMOVE AND REPLACE RCP STORM SEWER, 12"	50	LIN FT		

BIDDER'S PROPOSAL FOR MAKING THE IMPROVEMENTS:

18. This set of contract documents shall remain intact and shall be submitted in its entirety with the proposal.

(IF AN INDIVIDUAL)

SIGNATURE OF BIDDER _____ (SEAL)

BUSINESS ADDRESS _____

(IF A CO-PARTNERSHIP)

FIRM NAME _____ (SEAL)

SIGNED BY _____ (SEAL)

BUSINESS ADDRESS _____

Insert Names and _____
Addresses of All _____
Members of the firm _____

(IF A CORPORATION)

CORPORATE NAME _____

SIGNED BY _____

President

BUSINESS ADDRESS _____

(CORPORATE SEAL)

PRESIDENT _____

Insert Names of Officers SECRETARY _____

TREASURER _____

ATTEST: _____

Secretary

CONTRACT SPECIFICATION - DEVIATIONS AND SUBSTITUTIONS

Pursuant to Section 15 of the Instructions to Bidders, please list any and all deviations and substitutions made in the Contract Specifications here:

All deviations or substitutions must meet or exceed the specifications.

SUBMITTED BY:

Print Name of Company

BY: _____
Signature of person authorized to sign bid

TITLE _____

ADDRESS _____

E-MAIL ADDRESS: _____

PHONE (_____) _____

DATE _____

(NOTE: These affidavits must be completed by an authorized representative of the bidder)

AFFIDAVITS

Business Status of Bidder

BIDDER/APPLICANT:

Name

Principal place of business

Address

City, State, Zip Code

The Bidder is a:

Corporation
Partnership
Limited Liability Company
Sole Proprietorship
Other (please explain: _____)

Corporation

The state of incorporation is: _____

The registered agent of the corporation in Illinois is:

Name

Address

City, State, Zip

The officers of the corporation are:

President

Secretary

Vice President

Treasurer

The Corporation is authorized to do business in the State of Illinois

Limited Liability Company

The state of registration is: _____

The registered agent of the Limited Liability Company in Illinois is:

Name _____

Address _____

City State Zip _____

The registered office of the Limited Liability Company in Illinois is:

Address _____

City State Zip _____

The managers and members of the Limited Liability Company are:

Name

Name

Address

Address

City, State

City, State

The LLC is authorized to do business in the State of Illinois

Sole Proprietorship

The address of the sole proprietor is:

Address

City, State

The sole proprietor transacts business in Illinois under the following assumed names:

BID RIGGING AND BID ROTATING

Section 2: That in connection with this solicitation for bids/proposals:

- A. The bid is not made in the interest of or on behalf of any undisclosed person, partnership, company, association, organization or corporation;
- B. The bidder has not in any manner directly or indirectly sought by consultation, communication or agreement with anyone to fix the bid price of said bidder or any other bidder or to fix any overhead profit or cost element of such bid price or that of any other bidder or to secure any advantage against the public body awarding the contract or anyone interested in the proper contract;
- C. The bid is genuine and not collusive or sham;
- D. The prices or breakdowns thereof and any and all contents which had been quoted in this bid have not been knowingly disclosed by the bidder and will not be knowingly disclosed by the bidder directly or indirectly to any other bidder or any competitor prior to opening;
- E. All statements contained in such bid are true;
- F. No attempt has been made or will be made by the bidder to induce any other person or firm to submit a false or sham bid;
- G. No attempt has been made or will be made by the bidder to induce any other person or firm to submit or not to submit a bid for the purpose of restricting competition;

Section 2a

NON-COLLUSION

- A. No officer or employee of the City of Joliet has a direct or indirect pecuniary interest in this bid.
- B. No officer or employee of the City of Joliet has disclosed to the bidder any information related to the terms of a sealed bid.
- C. No officer or employee of the City of Joliet has informed the bidder that the bid will be accepted only if specified persons are included as subcontractors.
- D. Only the bidder will be entitled to the proceeds of the contract if this bid is accepted by the City of Joliet.
- E. This bid is made without the benefit of information obtained in violation of law.

Section 3. The undersigned further states that: (circle A or B)

- A. He is the person in the bidder's organization responsible within that organization for the decision as to the prices being bid herein and that he has not participated, and will not participate, in any action contrary to paragraphs A through G above; or
- B. He is not the person in the bidder's organization responsible within that organization for the decision as to the prices being bid herein but that he has been authorized to act as agent for the persons responsible for such decision in certifying that such persons have not participated, and will not participate, in any action contrary to paragraphs A through G above and as their agent does hereby so certify; and
- C. That he has not participated, and will not participate, in any action contrary to paragraphs A through G above.

Section 4. The undersigned certifies that the bidder has never been convicted for a violation of State laws prohibiting bid rigging or bid rotating.

***THE REQUIREMENTS OF THE
ILLINOIS DRUG FREE WORKPLACE ACT***

Section 5. The undersigned will publish a statement:

- A. Notifying employees that the unlawful manufacture, distribution, dispensation, possession, or use of a controlled substance is prohibited in the aforementioned company's workplace;
- B. Specifying the actions that will be taken against employees for violations of this prohibition;
- C. Notifying the employees that, as a condition of their employment to do work under the contract with the City of Joliet, the employees will:
 - 1. Abide by the terms of the statement; and
 - 2. Notify the aforementioned company of any criminal drug statute conviction for a violation occurring in the workplace not later than five (5) days after such a conviction.

- D. Establishing a drug free awareness program to inform the aforementioned company's employees about:
1. The dangers of drug abuse in the workplace;
 2. The aforementioned company's policy of maintaining a drug free workplace;
 3. Any available drug counseling, rehabilitation, and employee assistance programs; and
 4. The penalties that may be imposed upon employees for drug violations.
- E. Making it a requirement to give a copy of the statement required by Section 5. to each employee engaged in the performance of the contract with the City of Joliet and to post the statement in a prominent place in the workplace;
- F. Notifying the City of Joliet within ten (10) days after receiving notice under Section 5.C.2. from an employee or otherwise receiving actual notice of such a conviction;
- G. Imposing a sanction on, or requiring the satisfactory participation in a drug abuse assistance or rehabilitation program by, any employee who is so convicted, as required by Section 6., below;
- H. Training personnel to effectively assist employees in selecting a proper course of action in the event drug counseling, treatment, and rehabilitation is required and indicating that an effectively trained counseling and referral team is in place;
- I. Making a good faith effort to continue to maintain a drug free workplace through implementing these requirements.
- J. Making a good faith effort to continue to maintain a drug free workplace through implementation of this policy.

Section 6. The undersigned further affirms that within thirty (30) days after receiving notice from an employee of a conviction of a violation of the criminal drug statute occurring in the aforementioned company's workplace he shall:

- A. Take appropriate personnel action against such employee up to and including termination; or
- B. Require the employee to satisfactorily participate in a drug abuse assistance or rehabilitation program approved for such purposes by a federal, state, or local health, law enforcement, or other appropriate agency.

TAX COMPLIANCE

Section 7. The undersigned on behalf of the entity making the foregoing proposal certifies that neither the undersigned nor the entity is barred from contracting with the City of Joliet because of any delinquency in the payment of any tax administered by the State of Illinois, Department of Revenue, unless the undersigned or the entity is contesting, in accordance with the procedures established by the appropriate revenue act, liability of the tax or the amount of tax.

Section 8. The undersigned or the entity making the proposal or bid understands that making a false statement regarding delinquency in taxes is a Class A Misdemeanor and in addition, voids the contract and allows the municipality to recover all amounts paid to the individual or entity under the contract in a civil action.

NON DISCRIMINATION AND EQUAL EMPLOYMENT OPPORTUNITY

Section 9. This EQUAL EMPLOYMENT OPPORTUNITY CLAUSE is required by the Illinois Human Rights Act and the Rules and Regulations of the Illinois Department of Human Rights published at 44 Illinois Administrative Code Section 750, et seq.

Section 10. In the event of the contractor's noncompliance with any provision of this Equal Employment Opportunity Clause, the Illinois Human Right Act, or the Rules and Regulations for Public Contracts of the Department of Human Rights (hereinafter referred to as the Department) the contractor may be declared nonresponsible and therefore ineligible for future contracts or subcontracts with the State of Illinois or any of its political subdivisions or municipal corporations, and the contract may be canceled or avoided in whole or in part, and such other sanctions or penalties may be imposed or remedies involved as provided by statute or regulation.

During the performance of this contract, the contractor agrees:

- A. That it will not discriminate against any employee or applicant for employment because of race, color, religion, sex, national origin or ancestry; and further that it will examine

all job classifications to determine if minority persons or women are underutilized and will take appropriate affirmative action to rectify any such underutilization.

- B. That, if it hires additional employees in order to perform this contract, or any portion hereof, it will determine the availability (in accordance with the Department's Rules and Regulations for Public Contracts) of minorities and women in the area(s) from which it may reasonably recruit and it will hire for each job classification for which employees are hired in such a way that minorities and women are not underutilized.
- C. That, in all solicitations or advertisements for employees placed by it or on its behalf, it will state that all applicants will be afforded equal opportunity without discrimination because of race, color, religion, sex, marital status, national origin or ancestry, age, physical or mental handicap unrelated to ability, or an unfavorable discharge from military service.
- D. That it will send to each labor organization or representative of workers with which it has or is bound by a collective bargaining or other agreement or understanding, a notice advising such labor organization or representative of the contractor's obligations under the Illinois Human Rights Act and the Department's Rules and Regulations for Public Contract. If any such labor organization or representative fails or refuses to cooperate with the contractor in its efforts to comply with such Act and Rules and Regulations, the contractor will promptly so notify the Department and the contracting agency will recruit employees from other sources when necessary to fulfill its obligations thereunder.
- E. That it will submit reports as required by the Department's Rules and Regulations for Public Contracts, furnish all relevant information as may from time to time be requested by the Department or the contracting agency, and in all respects comply with the Illinois Human Rights Act and the Department's Rules and Regulations for Public Contracts.
- F. That it will permit access to all relevant books, records, accounts and work sites by personnel of the contracting agency and the Department for purposes of investigation to ascertain compliance with the Illinois Human Rights Act and the Department's Rules and Regulations for Public Contracts.
- G. That it will include verbatim or by reference the provisions of this Equal Employment Opportunity Clause in every subcontract it awards under which any portion of the contract obligations are undertaken or assumed, so that such provisions will be binding upon such subcontractor. In the same manner as the other provisions of this contract, the contractor will be liable for compliance with applicable provisions of this clause by such subcontractors; and further it will promptly notify the contracting agency and the Department in the event any subcontractor fails or refuses to comply therewith. In addition, the contractor will not utilize any subcontractor declared by the Illinois Human Rights Department to be ineligible for contracts or subcontracts with the State of Illinois or any of its political subdivisions or municipal corporations.

Section 11. For the purposes of subsection G of Section 10, "Subcontract" means any agreement, arrangement or understanding, written or otherwise, between a public contractor and any person under which any portion of the public contractor's obligations under one or more public contracts is performed, undertaken or assumed; the term "subcontract," however, shall not include any agreement, arrangement or understanding in which the parties stand in the relationship of an employer and an employee, or between a bank or other financial institution and its customers.

Section 12. It is expressly understood that the foregoing statements and representations and promises are made as a condition to the right of the bidder to receive payment under any award made under the terms and provisions of this bid.

Section 13. Have written sexual harassment policies that shall include, at a minimum, the following information: (i) the illegality of sexual harassment; (ii) the definition of sexual harassment under State law; (iii) a description of sexual harassment, utilizing examples; (iv) the vendor's internal complaint process including penalties; (v) the legal recourse, investigative and complaint process available through the Department and the Commission; (vi) directions on how to contact the Department and Commission; and (vii) protection against retaliation as provided by Section 6-101 of this Act. A copy of the policies shall be provided to the Department upon request.

Section 14. In the event that this contract is subject to Executive Order 11246, Seller certifies that it (1) is in compliance with Section 202 thereof and the Rules and Regulations issued thereunder; (2) does not and will not provide or maintain at any of its establishments, or permit its employees to perform their services at any location under its control where there are maintained, segregated facilities, and (3) agrees that a breach of this Certification violates the Equal Employment clause of Executive Order 11246. "Segregated Facilities," means facilities which are in fact segregated on a basis of race, color, creed, sex, religion or national origin, because of habit, local custom, or otherwise.

THE AMERICANS WITH DISABILITIES ACT

Section 15. As a condition of receiving this contract, the undersigned vendor certifies that services, programs and activities provided under this contract are and will continue to be in compliance with the Joliet Accessibility Code.

Signed by: _____
[name]

[title]

Subscribed and Sworn to before me this _____ day of _____, 20__.

By: _____
Notary Public

-seal-

STATE OF ILLINOIS)
)
 COUNTY OF WILL)

SS.

 *NOTE: THIS AFFIDAVIT MUST BE
 *COMPLETED BY THE CHIEF OFFICER
 *OF THE BIDDER

**AFFIDAVIT
 REGARDING BIDDER AVAILABILITY**

The undersigned, _____, being first duly sworn on oath and being duly authorized to make this Affidavit, hereby declares that the following is a true and correct statement relating to All uncompleted contracts of the undersigned for Federal, State, County, City and private work, including All subcontract work; and all pending low bids not yet awarded or rejected; and equipment available.

PART I. WORK UNDER CONTRACT

List below all work you have under contract as either a prime contractor or a subcontractor, including all pending low bids not yet awarded or rejected.

	1	2	3	4	5	Awards Pending	
County and Section No.							
Contract With							
Estimated Completion Date							
Total Contract Price							Total
Uncompleted Dollar Value							

PART II. UNCOMPLETED WORK TO BE DONE WITH YOUR OWN FORCES.

List below the uncompleted dollar value of work for each contract to be completed with your own forces. All work subcontract TO others will be listed on the reverse of this form. In a joint venture list only that portion of the work to be done by your company.

							TOTALS
Excav. Grading & Clearing							
Portland Cement Concrete Paving							
Bituminous Hot Mix Surface							
Bituminous Aggregate Mix							

STOP*

CHECK THE FOLLOWING LIST TO MAKE SURE THAT YOUR BID CONTAINS ALL OF THE REQUIRED DOCUMENTS.

- _____ 1. BID SECURITY
- _____ 2. BIDDING SCHEDULE
- _____ 3. BID PROPOSAL, DULY SIGNED
- _____ 4. ALL AFFIDAVITS, SIGNED & NOTARIZED

FAILURE TO INCLUDE ANY ONE OR ALL OF THE ABOVE MAY CONSTITUTE SUITABLE GROUNDS FOR REJECTION OF YOUR BID.

***(FOR CONSTRUCTION CONTRACTS ONLY)**

**This page
intentionally
left blank**

AGREEMENT

THIS AGREEMENT is entered into on the date stated below by and between the between the City of Joliet, an Illinois Municipal Corporation (hereinafter "City") and _____ (hereinafter "Contractor").

In consideration of the mutual promises of the parties set forth in the Contract Documents, the Contractor agrees to timely perform all work, furnish all labor and materials necessary for the proper completion of the work; and the City agrees to pay for the work as set forth in the Contract Documents. The Contractor further agrees to comply with the provisions of the *Prevailing Wage Act* (820 ILCS 130/1 et seq.).

The Contract Documents shall consist of the following documents which are hereby made part of this Agreement as if recited at length herein:

- 1) **Legal Notice to Bidders**
- 2) **Instruction to Bidders**
- 3) **General and Special Conditions**
- 4) **Specifications and Drawings**
- 5) **Proposal Schedule (consistent with Contract Documents)**
- 6) **Affidavits**
- 7) **Performance Bond and Payment Bond**
- 8) **Addenda**

IN WITNESS WHEREOF, the City and the Contractor, by their duly authorized representatives have hereunto set their hands this _____ day of _____, 20____.

**CITY OF JOLIET,
an Illinois Municipal Corporation,**

By: _____ **Print name of Contractor** _____

**James D. Hock
City Manager**

By: _____

Print Name: _____

Attest: _____

**Christa M. Desiderio
City Clerk**

Title: _____

Approved as to form:

**Marty Shanahan, Jr.
Corporation Counsel**